

## SP3006 Series 0.5pF, 8kV Diode Array

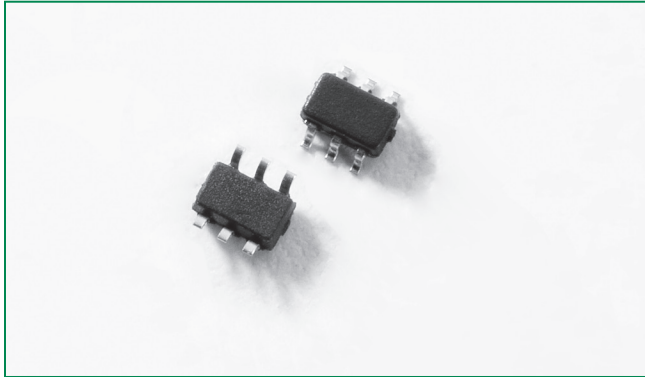

### Pinout and Functional Block Diagram

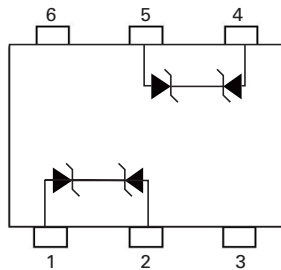

Life Support Note:

**Not Intended for Use in Life Support or Life Saving Applications**

The products shown herein are not designed for use in life sustaining or life saving applications unless otherwise expressly indicated.

### Description

The SP3006 Series includes ultra low capacitance back to-back zener diodes to protect high-speed ports of electronic equipment that may experience destructive electrostatic discharges (ESD). The robust diode can safely absorb repetitive ESD strikes at the maximum level specified in the IEC 61000-4-2 international standard (Level 4,  $\pm 8\text{kV}$  contact discharge) without performance degradation. Its very low loading capacitance makes it ideal for protecting high-speed data lines such as USB2.0, USB3.0, HDMI, and IEEE 1394.

### Features

- ESD protection of  $\pm 8\text{kV}$  contact discharge,  $\pm 15\text{kV}$  air discharge, (IEC61000-4-2)
- EFT protection, IEC61000-4-4, 40A (5/50ns)
- Lightning Protection, IEC61000-4-5, 2.0A (8/20 $\mu\text{s}$ )
- Low capacitance of 0.5pF (@  $V_R=0\text{V}$ )
- Low leakage current of 0.5 $\mu\text{A}$  (MAX) at 5V
- Miniature SOT563 package (1.6x1.6x0.5mm) saves board space

### Applications

- Game Consoles
- LCD/ PDP TVs
- DVD Players
- Desktops
- MP3/ PMP
- Digital Cameras
- Set Top Boxes
- Smart Phones
- Notebooks
- Computer Peripherals

### Application Example

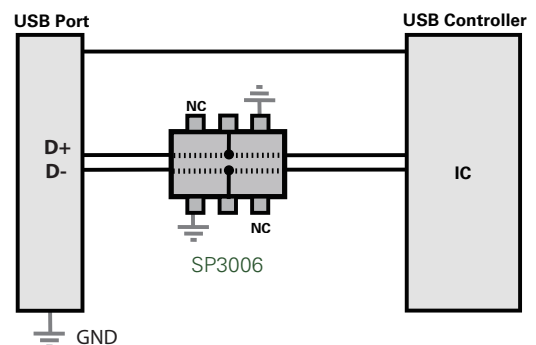

**Absolute Maximum Ratings**

Symbol	Parameter	Value	Units
$I_{PP}$	Peak Current ( $t_p=8/20\mu s$ )	2.0	A
$T_{OP}$	Operating Temperature	-40 to 125	°C
$T_{STOR}$	Storage Temperature	-55 to 150	°C

CAUTION: Stresses above those listed in "Absolute Maximum Ratings" may cause permanent damage to the device. This is a stress only rating and operation of the device at these or any other conditions above those indicated in the operational sections of this specification is not implied.

**Thermal Information**

Parameter	Rating	Units
Storage Temperature Range	-55 to 150	°C
Maximum Junction Temperature	150	°C
Maximum Lead Temperature (Soldering 20-40s)	260	°C

**Electrical Characteristics ( $T_{OP}=25^\circ C$ )**

Parameter	Symbol	Test Conditions	Min	Typ	Max	Units
Reverse Breakdown Voltage	$V_{BR}$	$I_R=5mA$	9.0			V
Reverse Standoff Voltage	$V_{RWM}$	$I_R \leq 1\mu A$			6	V
Reverse Leakage Current	$I_{LEAK}$	$V_R=5V$			0.5	$\mu A$
Clamp Voltage <sup>1</sup>	$V_C$	$I_{PP}=1A, t_p=8/20\mu s, Fwd$		12.5		V
		$I_{PP}=2A, t_p=8/20\mu s, Fwd$		15.0		V
ESD Withstand Voltage <sup>1</sup>	$V_{ESD}$	IEC61000-4-2 (Contact)	$\pm 8$			kV
		IEC61000-4-2 (Air)	$\pm 15$			kV
Diode Capacitance <sup>1</sup>	$C_{I/O-I/O}$	Reverse Bias=0V		0.5		pF

Note: 1. Parameter is guaranteed by design and/or device characterization.

**Capacitance vs. Reverse Voltage**

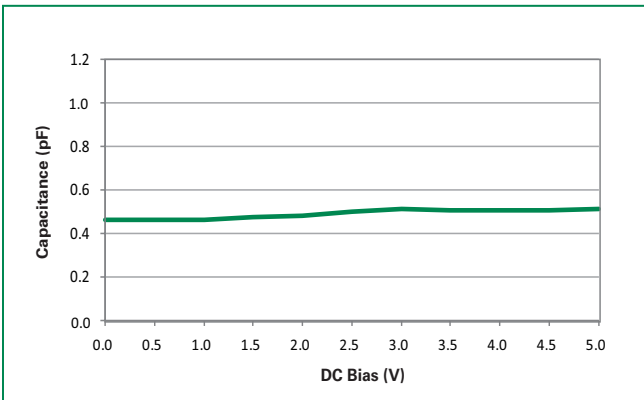

**Pulse Waveform**

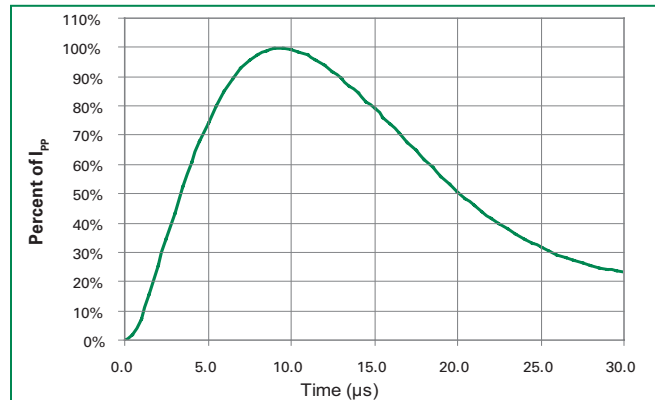

**Soldering Parameters**

Reflow Condition		Pb – Free assembly
Pre Heat	- Temperature Min ( $T_{s(min)}$ )	150°C
	- Temperature Max ( $T_{s(max)}$ )	200°C
	- Time (min to max) ( $t_s$ )	60 – 180 secs
Average ramp up rate (Liquidus) Temp ( $T_L$ ) to peak		3°C/second max
$T_{s(max)}$ to $T_L$ - Ramp-up Rate		3°C/second max
Reflow	- Temperature ( $T_L$ ) (Liquidus)	217°C
	- Temperature ( $t_L$ )	60 – 150 seconds
Peak Temperature ( $T_p$ )		260 <sup>+0/-5</sup> °C
Time within 5°C of actual peak Temperature ( $t_p$ )		20 – 40 seconds
Ramp-down Rate		6°C/second max
Time 25°C to peak Temperature ( $T_p$ )		8 minutes Max.
Do not exceed		260°C

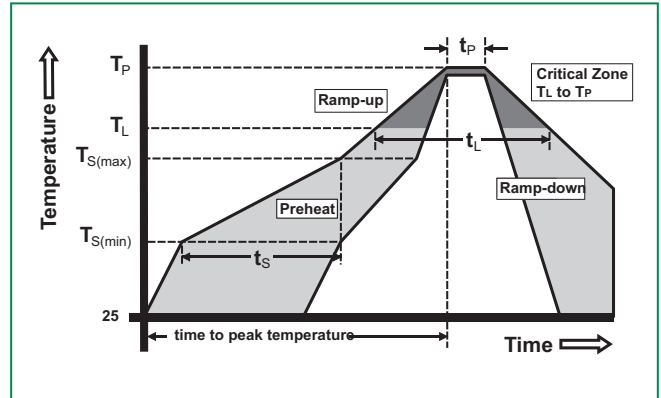

SP3006 Series

**Product Characteristics**

<b>Lead Plating</b>	Pre-Plated Frame
<b>Lead Material</b>	Copper Alloy
<b>Lead Coplanarity</b>	0.0004 inches (0.102mm)
<b>Substitute Material</b>	Silicon
<b>Body Material</b>	Molded Epoxy
<b>Flammability</b>	UL 94 V-0

- Notes :
- All dimensions are in millimeters
  - Dimensions include solder plating.
  - Dimensions are exclusive of mold flash & metal burr.
  - Blo is facing up for mold and facing down for trim/form, i.e. reverse trim/form.
  - Package surface matte finish VDI 11-13.

**Ordering Information**

Part Number	Package	Marking	Min. Order Qty.
SP3006-02XTG	SOT563	1 * 2	3000

**Part Numbering System**

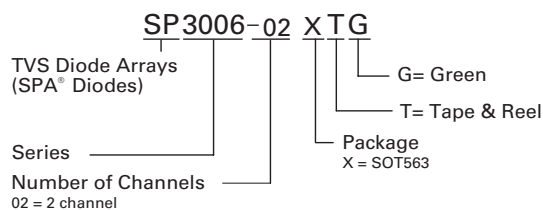

**Part Marking System**

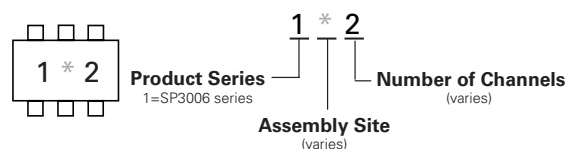

**Package Dimensions – SOT563**

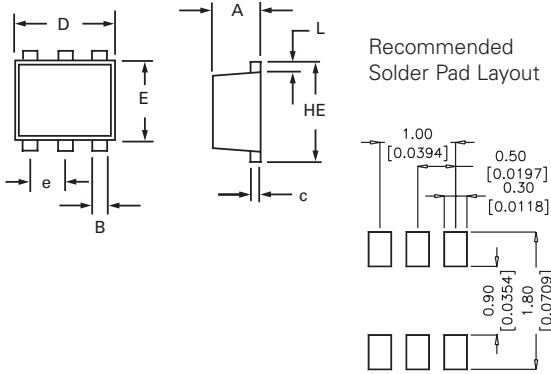

Package Pins	SOT 563			
	6			
	Millimeters		Inches	
	Min	Max	Min	Max
<b>A</b>	0.50	0.60	0.020	0.024
<b>B</b>	0.17	0.27	0.007	0.011
<b>c</b>	0.08	0.18	0.003	0.007
<b>D</b>	1.50	1.70	0.059	0.067
<b>E</b>	1.10	1.30	0.043	0.051
<b>e</b>	0.50 BSC		0.020 BSC	
<b>L</b>	0.10	0.30	0.004	0.012
<b>HE</b>	1.50	1.70	0.059	0.067

**Embossed Carrier Tape & Reel Specifications – SOT563**

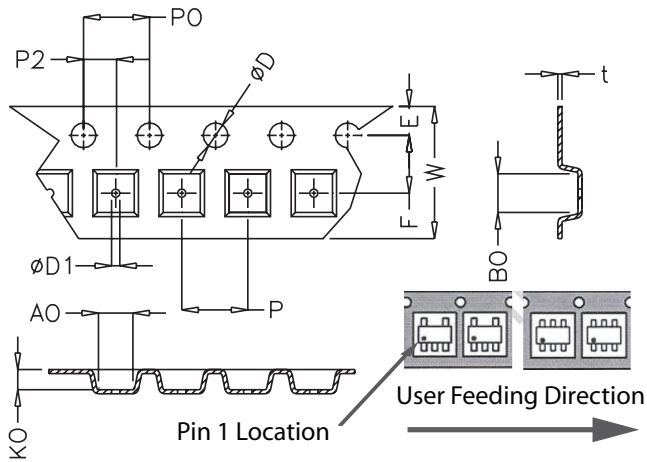

	Millimetres		Inches	
	Min	Max	Min	Max
<b>E</b>	1.65	1.85	0.064	0.073
<b>F</b>	3.45	3.55	0.135	0.139
<b>P2</b>	1.95	2.05	0.076	0.081
<b>D</b>	1.40	1.60	0.055	0.063
<b>D1</b>	0.45	0.55	0.017	0.021
<b>P0</b>	3.90	4.10	0.154	0.161
<b>10P0</b>	40.0+/- 0.20		1.574+/-0.008	
<b>W</b>	7.70	8.10	0.303	0.318
<b>P</b>	3.90	4.10	0.153	0.161
<b>A0</b>	1.73	1.83	0.068	0.072
<b>B0</b>	1.73	1.83	0.068	0.072
<b>K0</b>	0.64	0.74	0.025	0.029
<b>t</b>	0.22 max		0.009 max	