

## SP0502B Series 1pF 15kV Diode Arrays

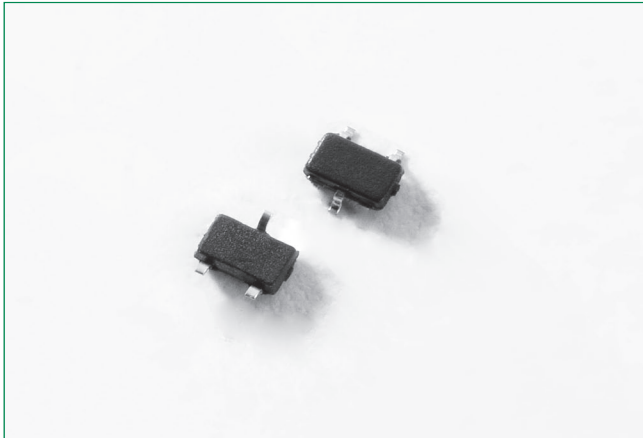

### Description

The SP0502B is a low capacitance TVS diode array designed to protect high-speed data interfaces from over-voltage caused by ESD (electrostatic discharge), CDE (Cable Discharge Events), and EFT (electrical fast transients). It has a typical capacitance of only 0.3pF (pin 1 to 2) making it suitable for use on circuits operating in excess of 3GHz without signal attenuation.

The SP0502BXTG is in a small SOT-523 package and each device can be configured to protect 1 bidirectional line or two unidirectional lines. The combination of small size, ultra-low capacitance, and high level of ESD protection makes it an ideal solution for applications such as HDMI, USB, MDDI, antennas, and DisplayPort.

### Functional Block Diagram and Pinout

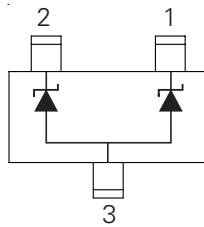

Life Support Note:

**Not Intended for Use in Life Support or Life Saving Applications**

The products shown herein are not designed for use in life sustaining or life saving applications unless otherwise expressly indicated.

### Features

- ESD protection of  $\pm 15\text{kV}$  contact discharge,  $\pm 20\text{kV}$  air discharge, (IEC61000-4-2)
- EFT, IEC61000-4-4, 40A (5/50ns)
- Lightning protection, IEC61000-4-5, 2A ( $t_p=8/20\mu\text{s}$ )
- Stand-off voltage of 5V
- Low capacitance of 1pF @  $V_R=0\text{V}$  (MAX)
- Low leakage current of 0.5 $\mu\text{A}$  at 5V (MAX)
- Small form factor (SOT523) and low profile (<1mm)
- No insertion loss to >3.0GHz
- AEC-Q qualified

### Applications

- High-Definition Multimedia Interface (HDMI)
- Mobile Display Digital Interface (MDDI)
- RF/Antenna Circuits
- USB 2.0
- DisplayPort

### Absolute Maximum Ratings

| Symbol     | Parameter                              | Value      | Units |
|------------|--|------------|-------|
| $P_{PK}$   | Peak Pulse Power ( $t_p=8/20\mu s$ )   | 25         | W     |
| $I_{PP}$   | Peak Pulse Current ( $t_p=8/20\mu s$ ) | 2          | A     |
| $T_{OP}$   | Operating Temperature                  | -40 to 125 | °C    |
| $T_{STOR}$ | Storage Temperature                    | -55 to 150 | °C    |

CAUTION: Stresses above those listed in "Absolute Maximum Ratings" may cause permanent damage to the device. This is a stress only rating and operation of the device at these or any other conditions above those indicated in the operational sections of this specification is not implied.

### Thermal Information

| Parameter                                   | Rating     | Units |
|---|------------|-------|
| Storage Temperature Range                   | -55 to 150 | °C    |
| Maximum Junction Temperature                | 150        | °C    |
| Maximum Lead Temperature (Soldering 20-40s) | 260        | °C    |

### Electrical Characteristics ( $T_{OP} = 25^\circ C$ )

| Parameter                          | Symbol        | Test Conditions   | Min      | Typ  | Max | Units    |
|------------------------------------|---------------|---|----------|------|-----|----------|
| Reverse Standoff Voltage           | $V_{RWM}$     | $I_R \leq 1\mu A$ , Pin1 or Pin2 to Pin3 and Pin1 to Pin2 |          |      | 5.0 | V        |
| Reverse Breakdown Voltage          | $V_{BR}$      | $I_t = 1mA$ , Pin1 or Pin2 to Pin3                        | 6        |      |     | V        |
| Leakage Current                    | $I_{LEAK}$    | $V_R = 5V$  |          |      | 0.5 | $\mu A$  |
| Clamp Voltage <sup>1</sup>         | $V_C$         | $I_{PP} = 1A$ , $t_p = 8/20\mu s$ , Pin 1 to Pin 2        |          |      | 12  | V        |
| Dynamic Resistance <sup>2</sup>    | $R_{DYN}$     | TLP, $t_p = 100ns$ , I/O to GND                           |          | 0.45 |     | $\Omega$ |
| ESD Withstand Voltage <sup>1</sup> | $V_{ESD}$     | IEC61000-4-2 (Contact Discharge)                          | $\pm 15$ |      |     | kV       |
|                                    |               | IEC61000-4-2 (Air Discharge)                              | $\pm 20$ |      |     | kV       |
| Diode Capacitance <sup>1</sup>     | $C_{I/O-I/O}$ | Reverse Bias=0V, f=1MHz;<br>Pin 1 to Pin2                 |          | 0.25 | 0.5 | pF       |
|                                    | $C_{I/O-GND}$ | Reverse Bias=0V, f=1MHz;<br>Pin 1 or Pin2 to Pin 3        |          |      | 1.0 | pF       |

Note:

1 Parameter is guaranteed by design and/or device characterization.

2 Transmission Line Pulse (TLP) with 100ns width and 200ps rise time.

**Pulse Waveform**

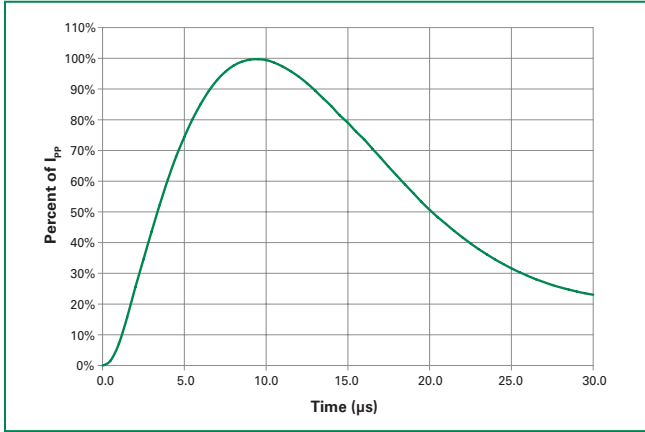

**Insertion Loss of Pin 1 to Pin 2 (I/O to I/O)**

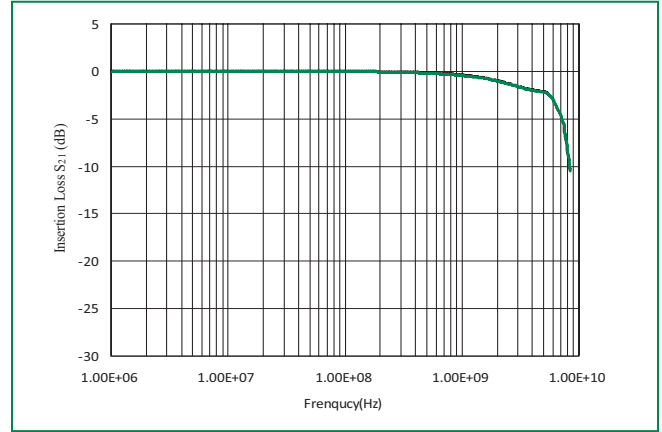

**Capacitance vs. Reverse Bias (Pin 1 or Pin 2 to Pin 3)**

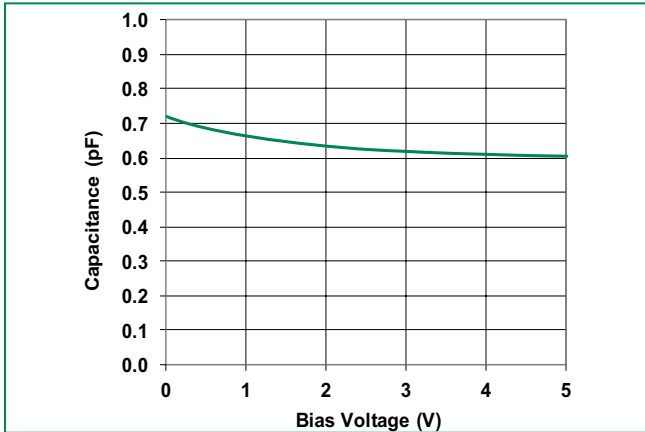

**Capacitance vs. Reverse Bias (I/O-I/O) (Pin 1 to Pin 2)**

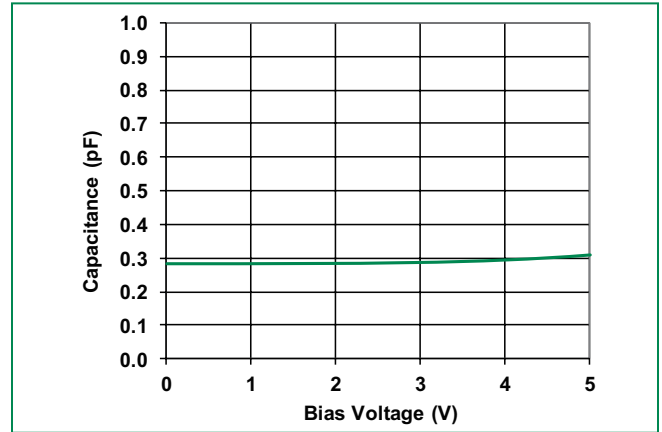

**Transmission Line Pulse (TLP)**

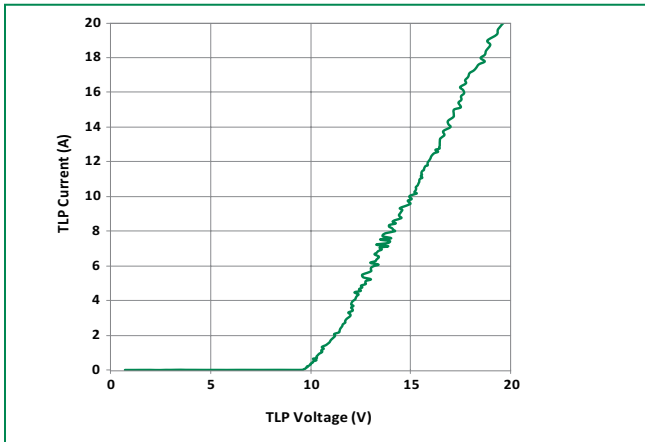

**Product Characteristics**

|                           |                         |
|---------------------------|-------------------------|
| <b>Lead Plating</b>       | Pre-Plated Frame        |
| <b>Lead Material</b>      | Copper Alloy            |
| <b>Lead Coplanarity</b>   | 0.0004 inches (0.102mm) |
| <b>Substrate material</b> | Silicon                 |
| <b>Body Material</b>      | Molded Epoxy            |
| <b>Flammability</b>       | UL 94 V-0               |

Notes :

1. All dimensions are in millimeters
2. Dimensions include solder plating.
3. Dimensions are exclusive of mold flash & metal burr.
4. Blo is facing up for mold and facing down for trim/form, i.e. reverse trim/form.
5. Package surface matte finish VDI 11-13.

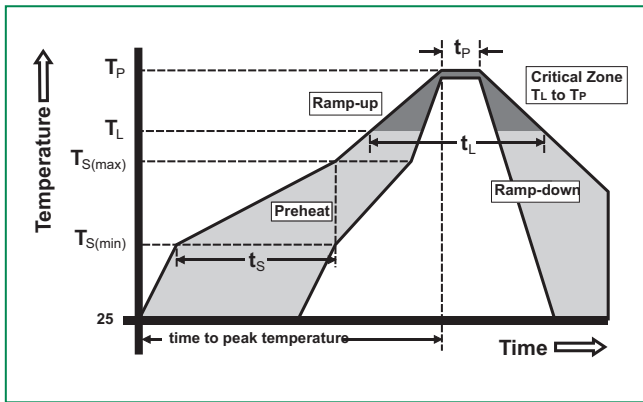

**Soldering Parameters**

|  |                                    |                  |
|--|------------------------------------|------------------|
| Reflow Condition                                       | Pb – Free assembly                 |                  |
| Pre Heat   | - Temperature Min ( $T_{s(min)}$ ) | 150°C            |
|  | - Temperature Max ( $T_{s(max)}$ ) | 200°C            |
|  | - Time (min to max) ( $t_s$ )      | 60 – 180 secs    |
| Average ramp up rate (Liquidus) Temp ( $T_L$ ) to peak | 3°C/second max                     |                  |
| $T_{s(max)}$ to $T_L$ - Ramp-up Rate                   | 3°C/second max                     |                  |
| Reflow   | - Temperature ( $T_L$ ) (Liquidus) | 217°C            |
|  | - Temperature ( $t_L$ )            | 60 – 150 seconds |
| Peak Temperature ( $T_P$ )                             | 260 <sup>+0/-5</sup> °C            |                  |
| Time within 5°C of actual peak Temperature ( $t_p$ )   | 20 – 40 seconds                    |                  |
| Ramp-down Rate   | 6°C/second max                     |                  |
| Time 25°C to peak Temperature ( $T_P$ )                | 8 minutes Max.                     |                  |
| Do not exceed  | 260°C                              |                  |

**Ordering Information**

| Part Number | Package | Size      | Marking | Min. Order Qty. |
|-------------|---------|-----------|---------|-----------------|
| SP0502BXTG  | SOT523  | 1.6x1.6mm | 3**     | 3000            |

**Part Numbering System**

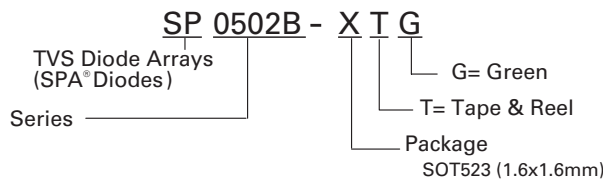

**Part Marking System**

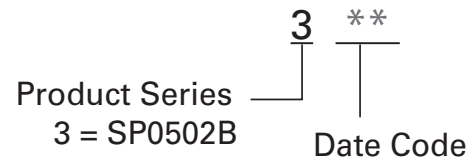

**Package Dimensions – SOT523**

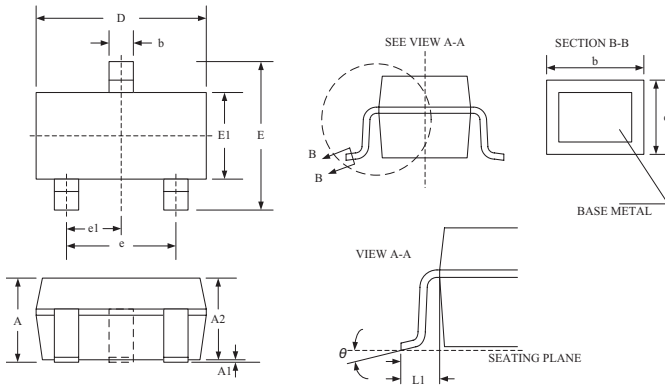

|           | Millimetres |      |      | Inches    |       |       |
|-----------|-------------|------|------|-----------|-------|-------|
|           | Min         | Typ  | Max  | Min       | Typ   | Max   |
| <b>A</b>  | 0.60        | -    | 0.90 | 0.023     | -     | 0.035 |
| <b>A1</b> | 0.00        | -    | 0.10 | 0.000     | -     | 0.004 |
| <b>A2</b> | 0.60        | 0.75 | 0.80 | 0.023     | 0.030 | 0.031 |
| <b>b</b>  | 0.15        | -    | 0.30 | 0.005     | -     | 0.012 |
| <b>c</b>  | 0.10        | -    | 0.20 | 0.003     | -     | 0.008 |
| <b>D</b>  | 1.50        | 1.60 | 1.70 | 0.059     | 0.063 | 0.067 |
| <b>e</b>  | 1.00 BSC    |      |      | 0.039 BSC |       |       |
| <b>e1</b> | 0.50 BSC    |      |      | 0.020 BSC |       |       |
| <b>E</b>  | 1.45        | 1.60 | 1.75 | 0.057     | 0.063 | 0.069 |
| <b>E1</b> | 0.75        | 0.80 | 0.85 | 0.029     | 0.031 | 0.033 |
| <b>L1</b> | 0.22 REF    |      |      | 0.009 RFE |       |       |
| <b>θ</b>  | 0°          | -    | 8°   | 0°        | -     | 8°    |

**Embossed Carrier Tape & Reel Specification – SOT523**

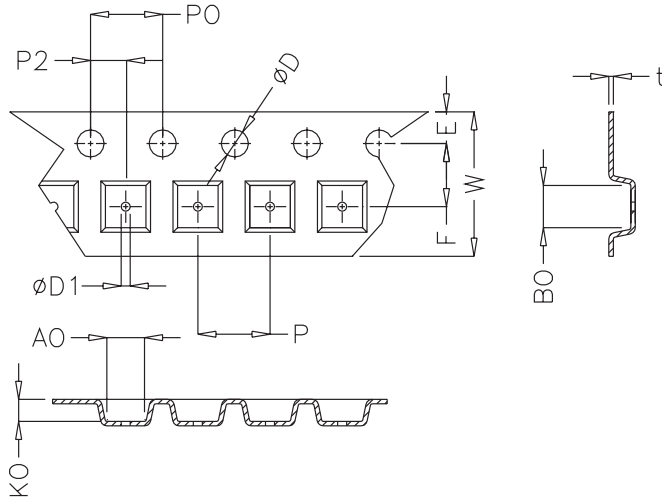

|             | Millimetres  |      | Inches        |       |
|-------------|--------------|------|---------------|-------|
|             | Min          | Max  | Min           | Max   |
| <b>E</b>    | 1.65         | 1.85 | 0.065         | 0.073 |
| <b>F</b>    | 3.45         | 3.55 | 0.135         | 0.139 |
| <b>P2</b>   | 1.95         | 2.05 | 0.077         | 0.081 |
| <b>D</b>    | 1.40         | 1.60 | 0.055         | 0.063 |
| <b>D1</b>   | 0.45         | 0.55 | 0.017         | 0.021 |
| <b>P0</b>   | 3.90         | 4.10 | 0.154         | 0.161 |
| <b>10P0</b> | 40.0+/- 0.20 |      | 1.574+/-0.008 |       |
| <b>W</b>    | 7.70         | 8.10 | 0.303         | 0.318 |
| <b>P</b>    | 3.90         | 4.10 | 0.153         | 0.161 |
| <b>A0</b>   | 1.73         | 1.83 | 0.068         | 0.072 |
| <b>BO</b>   | 1.73         | 1.83 | 0.068         | 0.072 |
| <b>K0</b>   | 0.64         | 0.74 | 0.025         | 0.029 |
| <b>t</b>    | 0.22 max     |      | 0.009 max     |       |