

1

2

3

4

A

A

B

B

C

C

D

D

E

F

FTP-628DCL30X Series PRODUCT SPECIFICATION

DATE	DOCUMENT CONTROL SECTION
	↑

					TITLE	FTP-628DCL30X Series Product Specification	
					DRAW No.	A1NA21207-3011/6	CUST
EDIT	DATE	DESIGN	CHECK	DESCRIPTION			
DESIGN	'01.02.07	佐藤	CHECK		APPLY	前田	1 / 80

1

Application

This specifications provide for control board FTP-628DSL30X series for thermal printer mechanism FTP-6X8MCL series.

The following products are included in this series.

- (1) FTP-628DCL300 Auto-cutter circuit non-installing.
- (2) FTP-628DCL301 Equipped with auto-cutter circuit

The printer mechanism which suits this control board is as shown in the table below.

Printer type			With platen detection switch	Without platen detection switch*1
2-inch mechanism	Normal type	Auto-cutter none	FTP-628MCL053 FTP-628MCL054	FTP-628MCL051 FTP-628MCL052
		With auto-cutter	FTP-628MCL353 FTP-628MCL354	FTP-628MCL351 FTP-628MCL352
	"ELM" type	Auto-cutter none	FTP-628MCL103	FTP-628MCL101
		With auto-cutter	_____	_____
3-inch mechanism	Normal type	Auto-cutter none	FTP-638MCL053 FTP-638MCL054	FTP-638MCL051 FTP-638MCL052
		With auto-cutter	FTP-638MCL353 FTP-638MCL354	FTP-638MCL351 FTP-638MCL352
	"ELM" type	Auto-cutter none	FTP-638MCL103	FTP-638MCL101
		With auto-cutter	_____	_____

Note *1): It is possible to apply by adding the mounting parts (jumper resistor).

The feature and the specification of the control board by the combination with the above-mentioned printer mechanism are described.

Please note this product enough in handling referring to notes of the appendix description before use.

DOCUMENT CONTROL SECTION	↑
DATE	

					TITLE FTP-628DCL30X Series Product Specification	
					DRAW No. A1NA21207-3011/6	
					CUST	
EDIT	DATE	DESIGN	CHECK	DESCRIPTION		
DESIGN			CHECK	APPLY	FUJITSU TAKAMISAWA COMPONENT LIMITED	
					2 / 80	

SECTION A Features

The features of the printer unit using this Control board and printer mechanism FTP628 MCL are as follows.

1. Maximum 60mm / second high- speed printing.(standard paper, high-speed print mode).
2. Compact and light weight.
3. Centronics conforming parallel interface.
4. Automatic starting point detection function by mark detection method is included.
5. Paper run out, platen release, head temperature abnormality, head voltage abnormality fuse blow out detection functions are included.
6. Various papers can be selected by commands setting.
7. The print of 384 dots/line (FTP628MCL series) and 576 dots/line (FTP-638MCL series) is supported by 8lines/ mm high resolutions.
8. Stable printing quality by temperature detection function.
9. Stable printing quality by thermal head driving voltage detection function.
10. Two types of fonts: 12 dot characters (12 x 24 dots and 24 x 24 dots) and 16 dot characters (8x16 dots and 16 x 16 dots) can be selected by commands.
11. MCU operation abnormality detection function by watchdog timer.
12. Fuse blow out detection functions for electric circuit to protect from over current of motor.
13. Various bar code commands are supported.
14. Paper auto-cut function.(Only the control board with the auto-cutter drive circuit .)
15. Power down function

DATE	SECTION
DOCUMENT	CONTROL

					TITLE		FTP-628DCL30X Series Product Specification	
					DRAW No.		A1NA21207-3011/6	
							CUST	
EDIT	DATE	DESIGN	CHECK	DESCRIPTION				
DESIGN			CHECK		APPLY	FUJITSU TAKAMISAWA COMPONENT LIMITED		3 / 80

SECTION B Circuit Configuration

The circuit configuration of the control board is as follows.

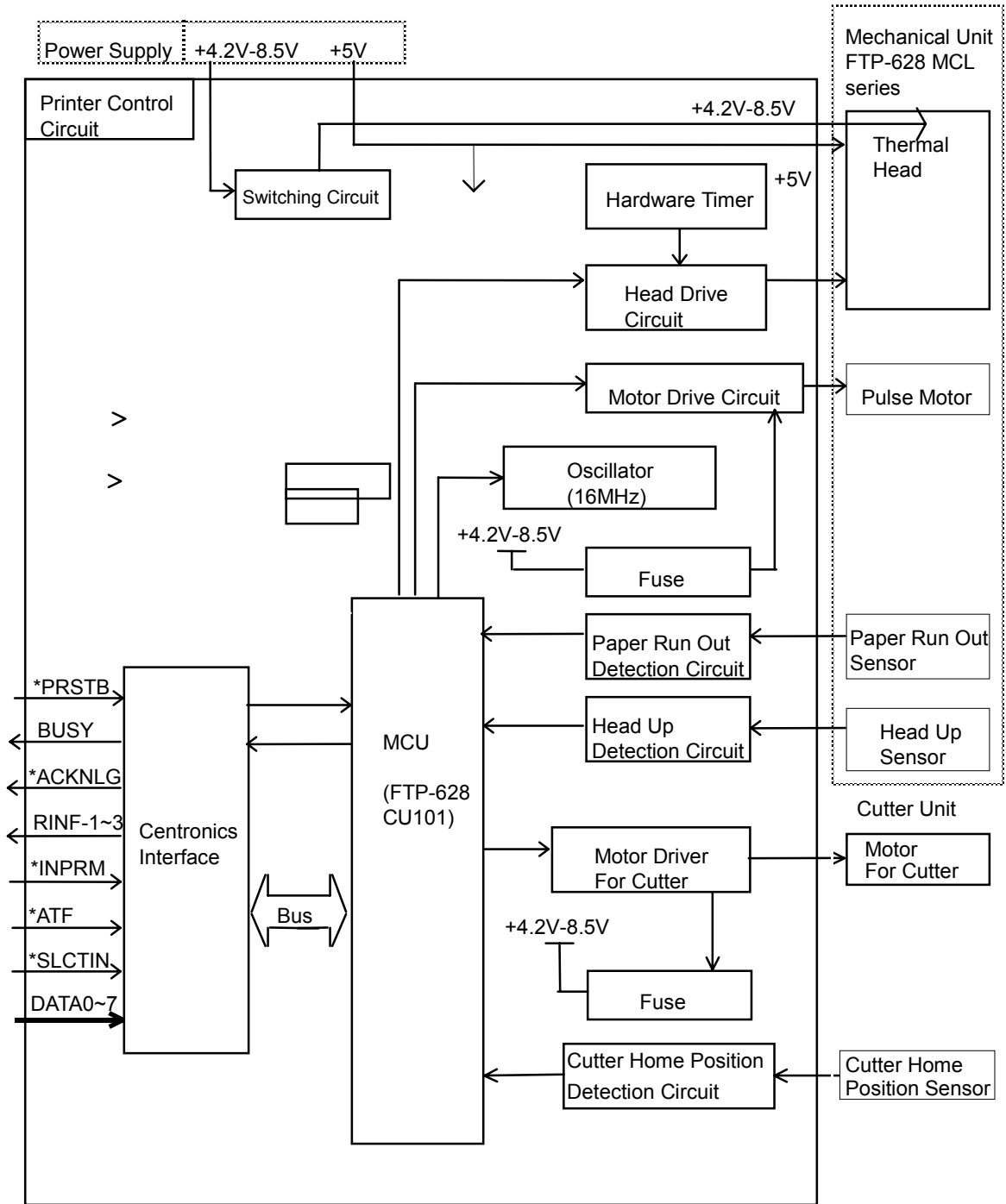

DATE	SECTION
DOCUMENT	CONTROL

					TITLE FTP-628DCL30X Series Product Specification	
					DRAW No. A1NA21207-3011/6	
					CUST	
EDIT	DATE	DESIGN	CHECK	DESCRIPTION		
DESIGN			CHECK	FUJITSU TAKAMISAWA COMPONENT LIMITED		
				4 / 80		

SECTION C

General Specifications

1. Outward appearance

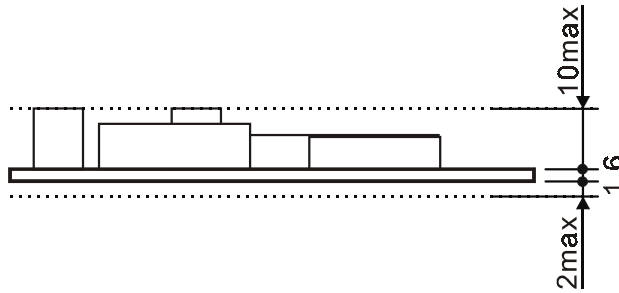
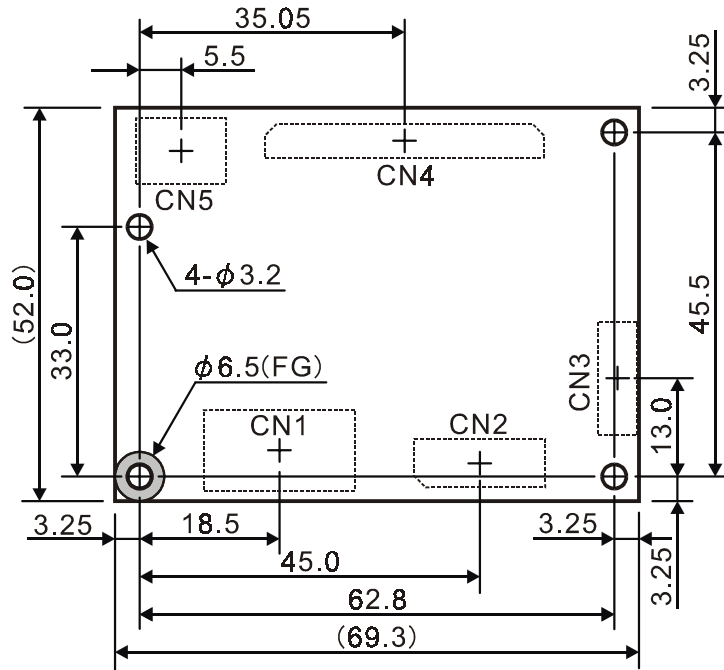

DATE	DOCUMENT CONTROL SECTION
↑	

				TITLE FTP-628DCL30X Series Product Specification	
				DRAW No. A1NA21207-3011/6	
				CUST	
EDIT	DATE	DESIGN	CHECK	DESCRIPTION	
DESIGN			CHECK	APPLY	FUJITSU TAKAMISAWA COMPONENT LIMITED
				5 / 80	

2. Connector composition

Parts number and the pin assignment of each connector are shown below. The direction is assumed to be the one seen from the control board side.

(1) CN1 (Power supply)

a. Parts number

S4B-PH-SM3-TB: J.S.T. Mfg Co,Ltd.

b. Pin assignment

No	Name of signal	Note
1	Vcc	Logic power supply terminal.
2	GND (Vcc)	Logic power supply grand terminal.
3	GND (Vdd)	Thermal head and motor power supply grand terminal.
4	GND (Vdd)	
5	Vdd	Thermal head and motor power supply terminal.
6	Vdd	

Note

A logic power supply grand terminal and, a thermal head and motor power grand terminal are connected together in the control board .

(2) CN2 (Centronics interface)

Refer to the paragraph of "D. the interface specification".

(3) CN3 (RS-232C interface)

This connector is not mounted.

DATE	DOCUMENT	CONTROL	SECTION
	↑		

				TITLE FTP-628DCL30X Series Product Specification	
				DRAW No. A1NA21207-3011/6	
				CUST	
EDIT	DATE	DESIGN	CHECK	DESCRIPTION	
DESIGN			CHECK	APPLY	
				FUJITSU TAKAMISAWA COMPONENT LIMITED	
				6 / 80	

(4) CN4 (Thermal printer)

a. Parts number
52610-3090: Molex

b. Pin assignment

No	Name of signal	Direction	Note
1	PSGND	--	Paper sensor power supply
2	PSVD	--	Paper sensor power supply grand
3	*PES	Input	Signal of paper sensor
4	HUP	Input	Signal of head-up sensor
5	HSVD	--	Head-up sensorpower5 supply
6	VH	--	Thermal head power supply
7	VH	--	
8	HD	Input	Input signal of print data
9	HCLK	Output	Synchronous clock for communication
10	GND	--	Thermal head power supply grand
11	GND	--	
12	*STB6 (*STB5)	Output	Thermal head energizing control signal
13	*STB5 (*STB4)	Output	
14	*STB4 (*STB3)	Output	
15	5VH	--	Power supply for thermal head control
16	TM1	Input	Thermally sensitive resistor input terminal 1
17	TM2	Input	Thermally sensitive resistor input terminal 2
	(*STB2)	(Output)	(Thermal head energizing control signal)
18	*STB3 (*STB1)	Output	Thermal head energizing control signal
19	*STB2 (*AE02)	Output	
20	*STB1 (*AE01)	Output	
21	GND	--	Thermal head power supply grand
22	GND	--	
23	*LAT	Output	Thermal head data latch signal
24	HD	Output	Print data signal
25	VH	--	Thermal head power supply
26	VH	--	
27	MT/*B	--	Stepping motor drive signal
28	MT/B	--	
29	MT/*A	--	
30	MT/A	--	

Note

Three-inch mechanism in () at two-inch mechanism besides ().

(5) CN5 (Auto-cutter)

a. Parts number
S4B-PH-SM3-TB: J.S.T. Mfg Co,Ltd.

b. Pin assignment

No	Name of signal	Direction	Note
1	CHP	Input	Auto-cutter home position detection signal
2	GND (+5V)	--	Logic grand
3	MT+	--	Auto-cutter motor drive signal
4	MT-		

DOCUMENT CONTROL SECTION

DATE

				TITLE FTP-628DCL30X Series Product Specification	
				DRAW No. A1NA21207-3011/6	
				CUST	
EDIT	DATE	DESIGN	CHECK	DESCRIPTION	
DESIGN			CHECK	APPLY	FUJITSU TAKAMISAWA COMPONENT LIMITED
				7 / 80	

3. Print Specification

(1) Printing System
Thermal printing system

(2) Printing Speed
(Head voltage 8.5V, Standard paper(PD150R), Room temperature, Under
64 concurrently energized dots/line, automatic division print mode)

		Maximum Printing Speed (mm / sec)		
		High-speed Mode	Medium-speed Mode	Low-speed Mode
Alphanumeric Katakana	Internal half size character 12x24	60	50	30
	Internal full size character 24x24			
	Internal half size character 8x16			
	Internal full size character 16x16			

*:Depends on the data transfer speed

(3) Thermal Head Configuration

Item	Specification	
	FTP-628	FTP-638
Resolution	8 dots / mm	
Heating Unit Size	0.125 mm (vertical) x 0.125 mm (horizontal)	
No. of Heating Units	384 dots/line	576 dots/line
Effective Printing Area	About 48 mm	About 72 mm

(4) Number of Digits of Print Characters

Print Mode	Type	No. of Digits	
		FTP-628	FTP-638
Alphanumeric Katakana	Internal half size character 12x24	32	48
	Internal full size character 24x24	16	24
	Internal half size character 8x16	48	72
	Internal full size character 16x16	24	36

(5) Type of Print Characters and Character Configuration

Print Mode	Type	No. of Characters
Alphanumeric Katakana	Internal half size character 12x24	159
	Internal full size character 24x24	159
	Internal half size character 8x16	159
	Internal full size character 16x16	159
International, Special	Internal half size character 12x24	195
	Internal full size character 24x24	195
	Internal half size character 8x16	195
	Internal full size character 16x16	195

DOCUMENT CONTROL SECTION

DATE

				TITLE FTP-628DCL30X Series Product Specification	
				DRAW No. A1NA21207-3011/6	
				CUST	
EDIT	DATE	DESIGN	CHECK	DESCRIPTION	
DESIGN			CHECK	APPLY	FUJITSU TAKAMISAWA COMPONENT LIMITED
				8 / 80	

(6) Print Mode

a. Character Space

Print Mode	Type	Character Space (No. of dots)
Alphanumeric Katakana	Internal half size character 12x24	12
	Internal full size character 24x24	24
	Internal half size character 8x16	8
	Internal full size character 16x16	16

b. Line Feed

Print Mode	Type	Line Feed (No. of dots)
Alphanumeric Katakana	Internal half size character 12x24	24 ~ 255
	Internal full size character 24x24	24 ~ 255
	Internal half size character 8x16	16 ~ 255
	Internal full size character 16x16	16 ~ 255

c. Print Character Type

Print Mode	Type of Print Characters
Alphanumeric Katakana	Internal half size character (12x24) Internal full size character (24x24) Internal half size character (8x16) Internal full size character (16x16)

d. Extended Mode

Print Mode	Extended Print Mode
Alphanumeric Katakana	Horizontal double size, reverse order, Black and white reversal, vertical double size, x4 size
Image	Reverse order, black and white reversal

e. Image Mode

	FTP-628	FTP-638
Max. No. of Dots/Line	384	576

(7) Printing Density

OD Value: 0.8 or more (density of solid black print area under standard print conditions)

Paper	Specified paper
Measuring Instrument	Sakura Density meter PDA 65

Discoloration of printing caused by paper is not included in this specification.

DATE DOCUMENT CONTROL SECTION

					TITLE FTP-628DCL30X Series Product Specification	
					DRAW No. A1NA21207-3011/6	
					CUST	
EDIT	DATE	DESIGN	CHECK	DESCRIPTION		
DESIGN			CHECK	APPLY	FUJITSU TAKAMISAWA COMPONENT LIMITED	
					9 / 80	

4. Paper Feed Specification

Paper Feed System	Friction feed
Line Feed Space	About 1/8 inch (when power is turned ON), n/203 inch (programmable)
Line Feed Speed	About 7.5 mm / sec (By * ATF signals)

5. Paper Specification

Specified Paper	Sensitive paper	TF50KS-E4	(Nippon Paper)
	Standard paper	TF60KS-E	(Japan Paper)
		PD150R	(Oji Paper)
	Medium-term storage paper	TF60KS-F1	(Nippon Paper)
		TP60KJ-R	(Nippon Paper)
		PD170R	(Oji Paper)
	Long-term storage paper	P220VBB-1	(Mitsubishi Paper)
		FH65BC-3H	(Oji Paper)
		PD160R	(Oji Paper)
		AFP-235	(Mitsubishi Paper)
	HA220AA	(Mitsubishi Paper)	
Paper Type	Thermo-sensitive roll paper (thermo-sensitive side is on outside)		

DATE	↑	DOCUMENT CONTROL SECTION

					TITLE FTP-628DCL30X Series Product Specification	
					DRAW No. A1NA21207-3011/6	
					CUST	
EDIT	DATE	DESIGN	CHECK	DESCRIPTION		
DESIGN			CHECK	APPLY	FUJITSU TAKAMISAWA COMPONENT LIMITED	
					10 / 80	

6. Functional Specification

(1) Self test print function

(2) Paper feed function

By * ATF signal

(3) Paper run out detection function

By internal sensor of printer mechanism

(4) Head up (platen open) detection function

By internal mechanical switch of printer mechanism

(5) Thermal head temperature detection function

By internal thermistor of printer mechanism

(6) Fuse blow out detection function

(7) Voltage detection function

(8) Internal RAM abnormality detection function

(9) Cutter operation abnormality detection function

(10) Motor power saving function

(11) Mark detection function

By GS < command

(12) MCU operation abnormality detection function

By watch dog timer

(13) Bar code print function

7. Control Command Specification

See "Section G Control Command Specification".

A

B

C

D

A

B

C

D

E

F

DATE	↑	DOCUMENT	CONTROL	SECTION

					TITLE FTP-628DCL30X Series Product Specification	
					DRAW No. A1NA21207-3011/6	
					CUST	
EDIT	DATE	DESIGN	CHECK	DESCRIPTION		
DESIGN			CHECK		APPLY	
					FUJITSU TAKAMISAWA COMPONENT LIMITED	
					11 / 80	

8. Power Consumption

(1). Driving head

Voltage: 4.2 – 8.5 V

Current: See the following table (model indicates a typical product).

Printing Rate	Speed	High-speed Print Mode	Medium Speed Print Mode	Low-speed Print Mode 30
	Model			
12.5%	628MCL	0.87 (0.93)	0.75 (0.93)	0.44 (0.62)
	638MCL	1.37 (1.53)	1.33 (1.53)	1.09 (1.53)
25.0%	628MCL	1.73 (1.84)	1.54 (1.84)	0.87 (1.23)
	638MCL	2.66 (3.02)	2.64 (3.02)	1.34 (1.83)
50.0%	628MCL	3.40 (3.64)	3.43 (3.64)	1.78 (2.45)
	638MCL	5.22 (5.85)	5.22 (5.85)	2.69 (3.60)
100.0%	628MCL	—	—	3.56 (4.82)
	638MCL	—	—	5.35 (6.93)

Units [A]

- Values inside () indicate peak values, and values outside () indicate mean values.

- Conditions

Voltage: 7.2 V

Head resistance: 169 Ω (176 Ω - 4%)

Ambient temperature: 25 °C

Paper: Standard paper (equivalent to PD150R)

Printing density: Applied dots are assumed to be evenly distributed.

- When mode by which head is automatically divided is set, the peak current changes the head division drive number in proportion to the print rate and is suppressed automatically. This case, the maximum number of dots where current flows is 64 dots, the peak current is 2.5 A. (Conditions are same to above mentioned.)

(2). Driving motor (feeding paper)

Voltage: 4.2 – 8.5 V

Current: 0.8 A (max)

(3). Driving motor (paper cutter)

Voltage: 5 V ± 5%

Current: 1.5 A (max)

(4). Driving logic

(Consumption current in standard control circuit which use this MCU)

Voltage: 5.0 V ± 5%

Current: 0.2 A (When the printer is driving usually, this current is maximum value.)

Current: 60 mA (When the printer is switching to power down function, this current is maximum value.)

DATE	DOCUMENT CONTROL SECTION	↑

				TITLE FTP-628DCL30X Series Product Specification	
				DRAW No. A1NA21207-3011/6	
				CUST	
EDIT	DATE	DESIGN	CHECK	DESCRIPTION	
DESIGN			CHECK	APPLY	FUJITSU TAKAMISAWA COMPONENT LIMITED
				12 / 80	

9. Operating Environment

During Operation	Operating Temperature	0 ~ 50 °C *1
	Operating Humidity	20 ~ 50% RH (no condensation)
During Stopping	Storage Temperature	-20 ~ 60 °C
	Storage Humidity	5 ~ 90%RH (no condensation) excluding thermosensitive paper

*1: The temperature range that guarantees print quality is 5 ~ 40 °C.

Note

1. When printing is continued under high temperature conditions, the printer may enter off-line status automatically because of the temperature rise of the head, and stop printing (head temperature abnormality). When the head temperature drops to normal, the printer automatically returns to on-line status and continues printing.

2. Relation between temperature and humidity in printing is as follows.

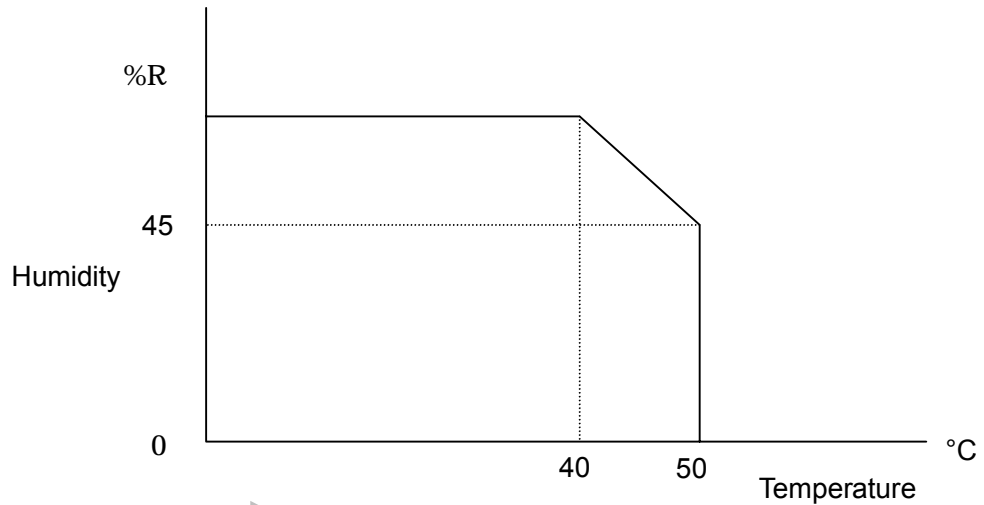

10. Noise

60 dB or less

Note

The measurement is a point 1m away from the device. 5°C and state of test print. However, the form cutting sound is excluded.

11. Life

(1). Thermal head life

Abrasion-proof:	50 km
Pulse-proof:	100 million pulses

[Condition]

Use form: PD150R	corresponding
Ambient temperature:	25 °C
Average print rate:	25 %

DATE	DOCUMENT CONTROL SECTION

					TITLE FTP-628DCL30X Series Product Specification	
					DRAW No. A1NA21207-3011/6	
					CUST	
EDIT	DATE	DESIGN	CHECK	DESCRIPTION		
DESIGN			CHECK	APPLY	FUJITSU TAKAMISAWA COMPONENT LIMITED	
					13 / 80	

12. Reliability, performance, and others

Vibration-proof (Non-operate)

At 1.0G or less:(splinter amplitude 0.15mm, 10~55~10Hz, and 1 octave/minute)

Do not operate by 20 cycles X, Y, and Z axially for each abnormal.

A

B

C

D

A

B

C

D

E

F

DATE	↑	DOCUMENT	CONTROL	SECTION

					TITLE FTP-628DCL30X Series Product Specification	
					DRAW No. A1NA21207-3011/6	
					CUST	
EDIT	DATE	DESIGN	CHECK	DESCRIPTION		
DESIGN			CHECK		APPLY	
					FUJITSU TAKAMISAWA COMPONENT LIMITED	
					14 / 80	

SECTION D

Interface Specification

1. Centronics Interface Specification

(1) General Specification

- | | |
|---------------------------------|--------------------------------------|
| a. System | 8-bit parallel interface |
| b. Maximum data receiving speed | About 28,000 bytes / sec |
| c. Synchronous System | By external strobe pulse
(*PRSTB) |
| d. Handshake | By BUSY / *ACKNLG signal |
| e. Input/Output level | CMOS level |

(2) Electrical Characteristics of Input / Output Signals

- a. Signal level (for output)
- (a) Space (logic = 0): + 3 V ~ + 12 V
- (b) Mark (logic = 1): - 3 V ~ - 12 V

b. Input condition

(a) *PRSTB

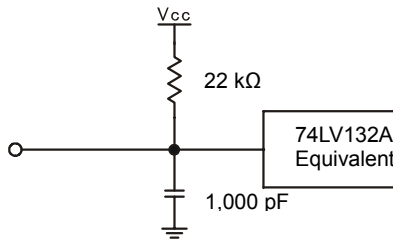

(b) PRDT0~7

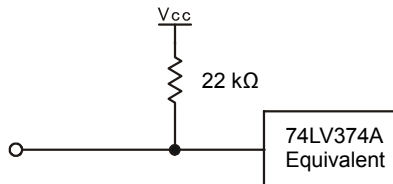

(c) *INPRM

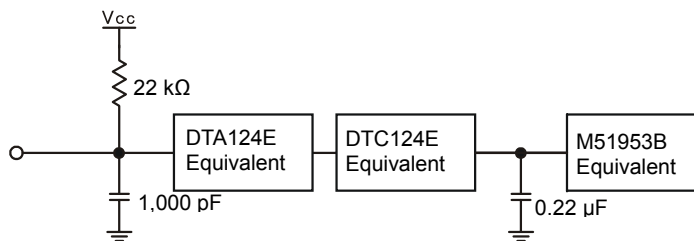

DATE	SECTION
DOCUMENT	CONTROL

					TITLE FTP-628DCL30X Series Product Specification	
					DRAW No. A1NA21207-3011/6	
					CUST	
EDIT	DATE	DESIGN	CHECK	DESCRIPTION		
DESIGN			CHECK		APPLY	
					FUJITSU TAKAMISAWA COMPONENT LIMITED	
					15 / 80	

(d) *SLCTIN,*ATF

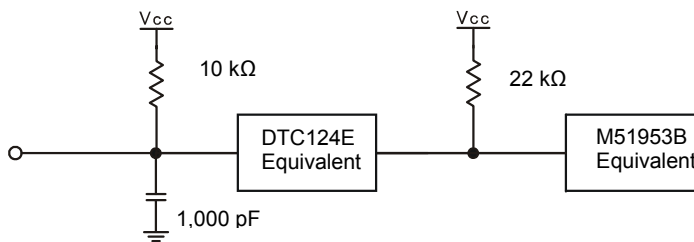

c. Output condition

(a) BUSY

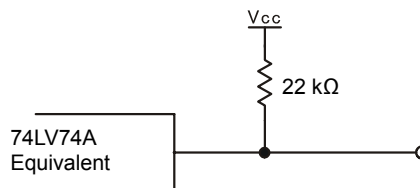

(b) *ACK,RINF1,2,3

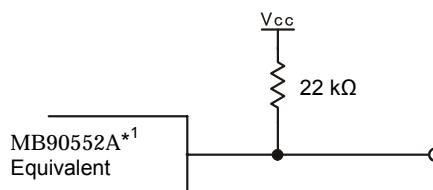

Note

For the input / output characteristics, see the data books of the MB90552A from FUJITSU LIMITED.

DATE	↑	DOCUMENT CONTROL SECTION

					TITLE		FTP-628DCL30X Series Product Specification	
					DRAW No.		A1NA21207-3011/6	
							CUST	
EDIT	DATE	DESIGN	CHECK	DESCRIPTION				
DESIGN			CHECK		APPLY	FUJITSU TAKAMISAWA COMPONENT LIMITED		16 / 80

(3) Pin array of I/O signal

No	Signal name	I/O	No	Signal name	I/O
1	*PRSTB	Input	2	*PRSTB-RET	---
3	PRDT0	Input	4	PRDT0-RET	---
5	PRDT1	Input	6	PRDT1-RET	---
7	PRDT2	Input	8	PRDT2-RET	---
9	PRDT3	Input	10	PRDT3-RET	---
11	PRDT4	Input	12	PRDT4-RET	---
13	PRDT5	Input	14	PRDT5-RET	---
15	PRDT6	Input	16	PRDT6-RET	---
17	PRDT7	Input	18	PRDT7-RET	---
19	*ACKLNG	Output	20	*ACKLNG-RET	---
21	BUSY	Output	22	BUSY-RET	---
23	RINF2	Output	24	*INPRM-RET	---
25	*SLCTIN	Input	26	*INPRM	Input
27	RINF1	Output	28	RINF3	Output
29	*ATF	Input	30	GND	---

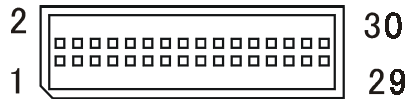

Note

- 1: It is shown that the signal to which "*" is attached is a negative-true logic signal.
- 2: The direction of I/O is the one having seen from the printer side.
- 3: Parts number of the use connector is BM30B-SRDS-G-TF (J.S.T. Mfg,Ltd.) equivalent goods.
4. The other party side connector must use the following parts number equivalent goods.
SHDR-30V-S-B (J.S.T. Mfg,Ltd.)
4. "- RET" All signals are connected with GND.
5. The pin array chart of the connector is the one having seen from the setting side.

(4) Recommended cable specification

Wire :AWG30(7/0.102) equivalen
 Length of cable :0.5 m or less

DATE	↑	SECTION
		CONTROL
DATE	↑	DOCUMENT

				TITLE FTP-628DCL30X Series Product Specification	
				DRAW No. A1NA21207-3011/6	
				CUST	
EDIT	DATE	DESIGN	CHECK	DESCRIPTION	
DESIGN			CHECK	APPLY	FUJITSU TAKAMISAWA COMPONENT LIMITED
				17/80	

(5) Description of Signals

Signal Name	Function																																																																																	
*INPRM	<p>1) Signal to initialize printer</p> <p>2) Normally "High". A hardware reset is executed when "Low" changes to "High".</p> <p>3) This signal sets the printer status as follows.</p> <table border="0"> <tr><td>1</td><td>Print buffer</td><td>Clear</td></tr> <tr><td>2</td><td>Line feed pitch</td><td>About 3.25 mm</td></tr> <tr><td>3</td><td>ANK character pitch</td><td>12 dots / character</td></tr> <tr><td>4</td><td>Print character type</td><td>12x24 dots half size character</td></tr> <tr><td>5</td><td>Page length setting</td><td>44 lines, about 143 mm</td></tr> <tr><td>6</td><td>Double width specification</td><td>Clear</td></tr> <tr><td>7</td><td>Black and white reversal printing</td><td>Clear</td></tr> <tr><td>8</td><td>Reverse order printing</td><td>Clear</td></tr> <tr><td>9</td><td>Receive code buffer</td><td>Clear</td></tr> <tr><td>10</td><td>Character code</td><td>Set to Japanese characters</td></tr> <tr><td>11</td><td>International character setting</td><td>Japan</td></tr> <tr><td>12</td><td>Printing speed setting</td><td>High-speed mode</td></tr> <tr><td>13</td><td>Horizontal tab setting</td><td>Every 8 characters</td></tr> <tr><td>14</td><td>ark detection to start point setting</td><td>About 2 mm</td></tr> <tr><td>15</td><td>Paper run out detection setting</td><td>Valid *1</td></tr> <tr><td>16</td><td>Head up (platen open) detection setting</td><td>Valid *1</td></tr> <tr><td>17</td><td>Temperature abnormality detection setting</td><td>Valid *1</td></tr> <tr><td>18</td><td>Voltage abnormality detection setting</td><td>Valid *1</td></tr> <tr><td>19</td><td>Paper type</td><td>Continuous paper</td></tr> <tr><td>20</td><td>Vertical double size print mode specification</td><td>Clear</td></tr> <tr><td>21</td><td>X4 size print mode specification</td><td>Clear</td></tr> <tr><td>22</td><td>Print quality setting</td><td>Type 3</td></tr> <tr><td>23</td><td>Automatic status transmission mode specification</td><td>Clear</td></tr> <tr><td>24</td><td>90° character rotation</td><td>Clear</td></tr> <tr><td>25</td><td>Paper auto-feed amount setting</td><td>20mm</td></tr> <tr><td>26</td><td>Motor off-time setting</td><td>One excitation time = 0.5 sec Excitation holding time = 1.0 sec</td></tr> <tr><td>27</td><td>automatic division print setting</td><td>Clear</td></tr> </table> <p>*1:This can be set to invalid by the *SLCTIN signal.</p> <p>4) If the *ATF signal in "Low" status is initialized by this signal, the test function mode is set.</p> <p>5) If initialization is executed when the data is in the buffer, this data is deleted.</p> <p>6) During initialization, DTR outputs "Mark". After initialization end if an error does not occur becomes "Space". After initialization end if an error occurs DTR keeps "Mark".</p>	1	Print buffer	Clear	2	Line feed pitch	About 3.25 mm	3	ANK character pitch	12 dots / character	4	Print character type	12x24 dots half size character	5	Page length setting	44 lines, about 143 mm	6	Double width specification	Clear	7	Black and white reversal printing	Clear	8	Reverse order printing	Clear	9	Receive code buffer	Clear	10	Character code	Set to Japanese characters	11	International character setting	Japan	12	Printing speed setting	High-speed mode	13	Horizontal tab setting	Every 8 characters	14	ark detection to start point setting	About 2 mm	15	Paper run out detection setting	Valid *1	16	Head up (platen open) detection setting	Valid *1	17	Temperature abnormality detection setting	Valid *1	18	Voltage abnormality detection setting	Valid *1	19	Paper type	Continuous paper	20	Vertical double size print mode specification	Clear	21	X4 size print mode specification	Clear	22	Print quality setting	Type 3	23	Automatic status transmission mode specification	Clear	24	90° character rotation	Clear	25	Paper auto-feed amount setting	20mm	26	Motor off-time setting	One excitation time = 0.5 sec Excitation holding time = 1.0 sec	27	automatic division print setting	Clear
1	Print buffer	Clear																																																																																
2	Line feed pitch	About 3.25 mm																																																																																
3	ANK character pitch	12 dots / character																																																																																
4	Print character type	12x24 dots half size character																																																																																
5	Page length setting	44 lines, about 143 mm																																																																																
6	Double width specification	Clear																																																																																
7	Black and white reversal printing	Clear																																																																																
8	Reverse order printing	Clear																																																																																
9	Receive code buffer	Clear																																																																																
10	Character code	Set to Japanese characters																																																																																
11	International character setting	Japan																																																																																
12	Printing speed setting	High-speed mode																																																																																
13	Horizontal tab setting	Every 8 characters																																																																																
14	ark detection to start point setting	About 2 mm																																																																																
15	Paper run out detection setting	Valid *1																																																																																
16	Head up (platen open) detection setting	Valid *1																																																																																
17	Temperature abnormality detection setting	Valid *1																																																																																
18	Voltage abnormality detection setting	Valid *1																																																																																
19	Paper type	Continuous paper																																																																																
20	Vertical double size print mode specification	Clear																																																																																
21	X4 size print mode specification	Clear																																																																																
22	Print quality setting	Type 3																																																																																
23	Automatic status transmission mode specification	Clear																																																																																
24	90° character rotation	Clear																																																																																
25	Paper auto-feed amount setting	20mm																																																																																
26	Motor off-time setting	One excitation time = 0.5 sec Excitation holding time = 1.0 sec																																																																																
27	automatic division print setting	Clear																																																																																

DOCUMENT CONTROL SECTION

DATE

				TITLE		FTP-628DCL30X Series Product Specification	
				DRAW No.		A1NA21207-3011/6	
						CUST	
EDIT	DATE	DESIGN	CHECK	DESCRIPTION			
DESIGN			CHECK	APPLY	FUJITSU TAKAMISAWA COMPONENT LIMITED		18 / 80

Signal Name	Function
*ATF	1) Paper feed request signal 2) Normally "High". Paper is fed in "Low" status. 3) When paper is fed by this signal, the internal processing time is not constant. Use the line feed command for a more accurate paper feed. 4) When paper feed is executed the printer enters off-line status. And DTR becomes "Mark". 5) When paper is fed by receiving this signal, the position on the page does not change. If paper is fed by the new page command after paper is fed by this signal, the page start position deviates. 6) If this signal in "Low" status is initialized by the *INPRM signal or the power supply is turned on, the test function mode is set.
*SLCTIN	1) Signal that makes the detection functions of initial setting invalid 2) If power is turned ON or if initialization by the *INPRM signal is executed when this signal is "Low", paper run out detection, head up (platen open) detection, head temperature abnormality detection and head driving voltage abnormality detection become invalid.

A

B

C

D

A

B

C

D

E

F

DATE	↑
	DOCUMENT CONTROL SECTION

					TITLE FTP-628DCL30X Series Product Specification	
					DRAW No. A1NA21207-3011/6	
					CUST	
EDIT	DATE	DESIGN	CHECK	DESCRIPTION		
DESIGN			CHECK		APPLY	
					FUJITSU TAKAMISAWA COMPONENT LIMITED	
					19/80	

(6) Description of Output Signals

Signal Name	Function					
*ACKNLG	1) Reply signal to *PRSTB signal 2) Negative logic pulse signal which is output when data input completes					
BUSY	1) "High" indicates that printer is busy, which means that data cannot be received. 2) This signal is "High" when receiving data, printing, feeding paper, and when in error status and in initialization operation.					
RINF1~3	1) This signal indicates the error status of the printer. 2) The following table shows each error status.					
	Error Status			RINF-1	RINF-2	RINF-3
	A	Paper run out	Low	High	Low	
	B	Head up (platen open)	High	Low	Low	
	C	Head temperature abnormality	High	Low	High	
	D	Head voltage abnormality	Low	High	High	
	E	Hardware abnormality	High	High	High	
	F	Mark detection abnormality	Low	Low	Low	
	G	Normal	Low	Low	High	
	3) Each error status is output in the following status. a. Paper run out is detected and printer is in off-line status. c. Head up (platen open) is detected and printer is in off-line status. c. Head temperature abnormality is detected and printer is in off-line status. d. Head driving voltage is not in 3.6V- 9.8V range. e. The following hardware abnormalities are detected. <ul style="list-style-type: none"> • Internal RAM abnormality • Thermo run away of head • Fuse blow out • Cutter abnormality f. Printer is in the following status. <ul style="list-style-type: none"> • Mark is not detected within the page. This status is held until the next command is received. • MCU is in hardware reset status g. Printer is in the following status. <ul style="list-style-type: none"> • Normal status 4) Error detection priority Hardware > head voltage > head temperature > paper run out > head up (platen open) > mark undetected > normal					

A

B

C

D

A

B

C

D

E

F

DOCUMENT CONTROL SECTION



DATE

					TITLE FTP-628DCL30X Series Product Specification				
					DRAW No. A1NA21207-3011/6			CUST	
EDIT	DATE	DESIGN	CHECK	DESCRIPTION					
DESIGN			CHECK		APPLY		FUJITSU TAKAMISAWA COMPONENT LIMITED		20/80

SECTION E Timing Chart

1. Centronics Interface

(1) When data is received:

[Figure 1]

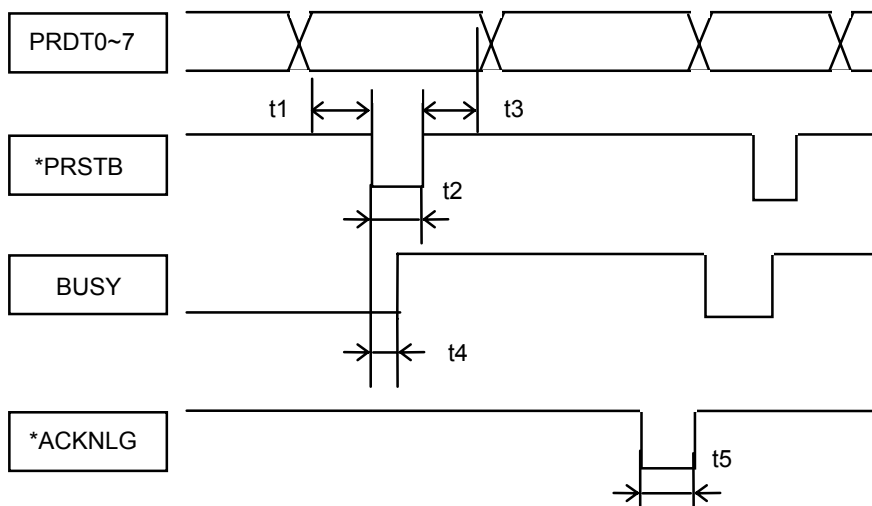

- a. Data set time $t_1 \geq 0.5 \mu\text{sec}$
- b. *PRSTB pulse width $t_2 \geq 0.5 \mu\text{sec}$
- c. Data hold time $t_3 \geq 0.5 \mu\text{sec}$
- d. From *PRSTB input to BUSY = "H" $t_4 \leq 0.5 \mu\text{sec}$
- e. *ACKNLG pulse time t_5 about $5.0 \mu\text{sec}$

DATE	
DOCUMENT CONTROL SECTION	↑

				TITLE FTP-628DCL30X Series Product Specification	
				DRAW No. A1NA21207-3011/6	
				CUST	
EDIT	DATE	DESIGN	CHECK	DESCRIPTION	
DESIGN			CHECK	APPLY	
				FUJITSU TAKAMISAWA COMPONENT LIMITED	
				21 / 80	

(2) When power is turned ON (no error):

[Figure 2]

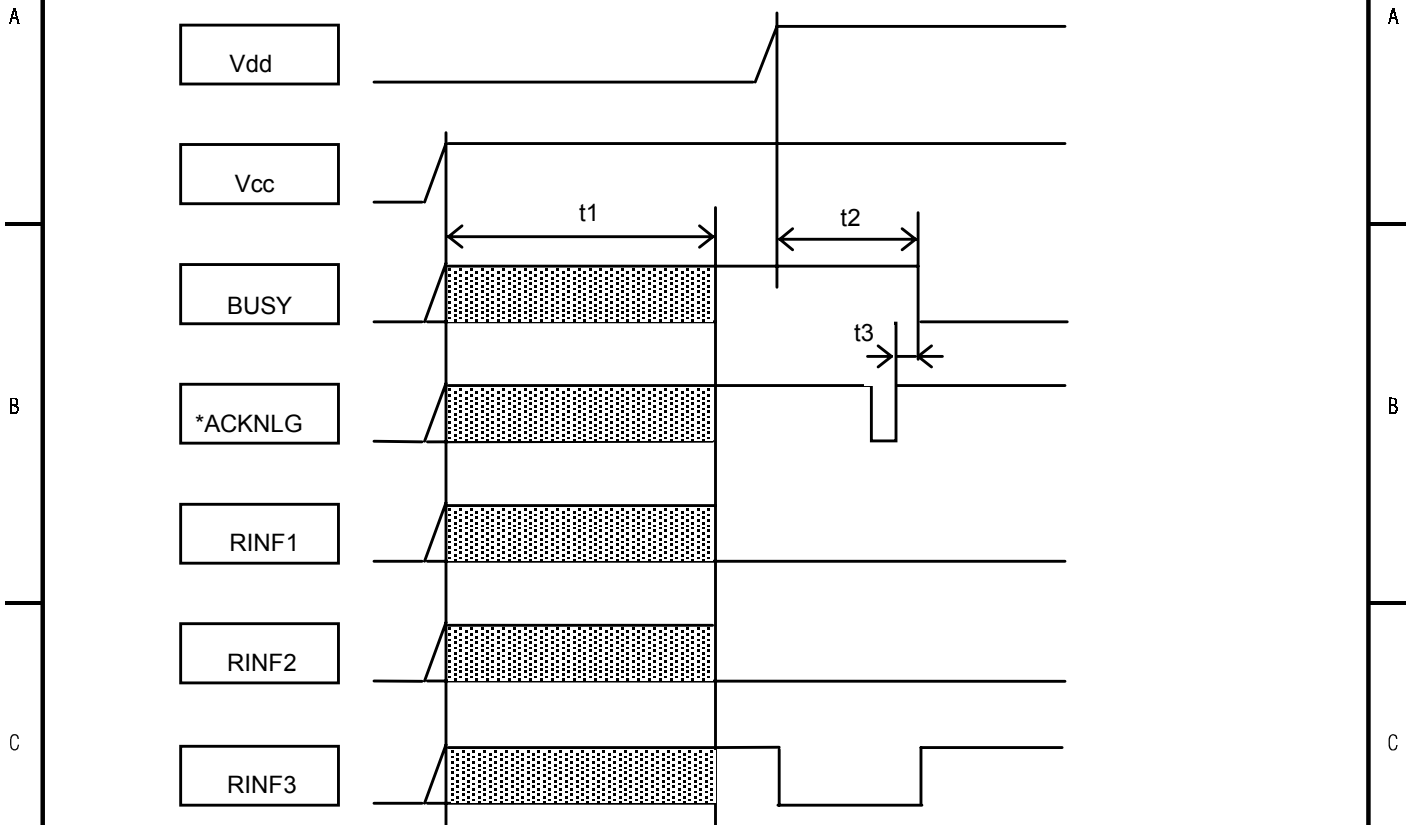

- a. MCU reset time $t1 \leq 90 \text{ msec}$
- b. Initialization time $t2 \leq 1.2 \text{ sec}$
- c. From *ACKNLG = "↑" to BUSY = "L" $t3 \leq 120 \text{ msec}$

Note

To set paper run out, head up (platen open), head voltage abnormality and head temperature abnormality detection to invalid at the initial setting, set the *SLCTIN signal to "Low" level before turning power ON.

The shaded area in the above figure indicates logic undefined status.

DATE DOCUMENT CONTROL SECTION

					TITLE FTP-628DCL30X Series Product Specification	
					DRAW No. A1NA21207-3011/6	
					CUST	
EDIT	DATE	DESIGN	CHECK	DESCRIPTION		
DESIGN			CHECK	APPLY	FUJITSU TAKAMISAWA COMPONENT LIMITED	
					22 / 80	

(3) *INPRM Reset Timing (No error and in standby status when data is not in buffer)

[Figure 3]

A

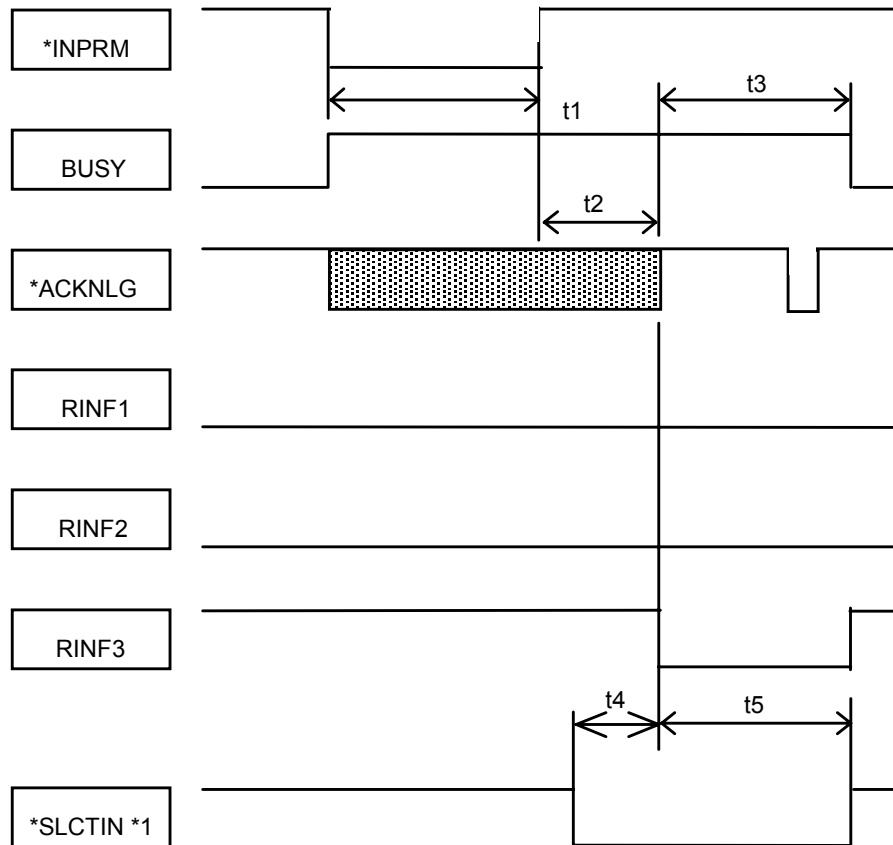

B

C

- a. *INPRM = "L" time $t1 \geq 10 \mu\text{sec}$
- b. Initialization transition time $t2 \leq 120 \text{ msec}$
- c. Initialization time $t3 \leq 1.6 \text{ sec}$
- d. *SLCTIN setup time $t4 \geq 0 \text{ msec}$
- e. *SLCTIN hold time $t5 \geq t3$

Note

To set paper run out, head up (platen open), head voltage abnormality and head temperature abnormality detection to invalid at the initial setting, set the *SLCTIN signal to "Low" level before turning power ON.

The shaded area in the above figure indicates logic undefined status.

DOCUMENT CONTROL SECTION

DATE

					TITLE		FTP-628DCL30X Series Product Specification	
					DRAW No.		A1NA21207-3011/6	
							CUST	
EDIT	DATE	DESIGN	CHECK	DESCRIPTION				
DESIGN			CHECK		APPLY	FUJITSU TAKAMISAWA COMPONENT LIMITED		23 / 80

SECTION F

Functional Specification

1. Centronics Interface

(1) Test Print Function

Test Print Function	<p>1) The self-test print function is selected when power is turned ON or if initialization by the *INPRM signal is executed while the *ATF signal is "Low".</p> <p>2) The mode automatically changes as follows.</p> <div style="text-align: center; margin: 10px 0;"> <pre> graph LR a((a)) --> b((b)) b --> c((c)) c --> d((d)) d --> e((e)) e --> f((f)) f --> g((g)) g --> h((h)) h --> i((i)) i --> j((j)^{*1}) j --> a </pre> </div> <p>a. 50% checkered printing (2 lines) b. 25% checkered printing (3 lines) c. Printer setting status printing d. Japanese character set (12x24) (1 set) e. Overseas character set (12x24) (1 set) f. International characters (12x24) (8 lines) g. Japanese character set (8x16) (1 set) h. Overseas character set (8x16) (1 set) i. International characters (8x16) (8 lines) j. Paper cut*1</p> <p>3) 8x16 font characters are printed 4 times size mode. And the other characters are printed normal size mode/ 4) In the internal set state, the printer is in states of RS232C interface set and the other extend function sets. 5) The self-test print mode is for standard paper (equivalent to PD150R) 6) If an error occurs during test printing, printing stops. When error is cleared, about one second later printing restarts. 7) To clear test printing, shut power OFF or execute initialization by the *INPRM signal when *ATF is set to "High".</p>
---------------------	---

*1: Cut only when cutter driving circuit is mounted

DOCUMENT CONTROL	SECTION
DATE	↑

				TITLE FTP-628DCL30X Series Product Specification	
				DRAW No. A1NA21207-3011/6	
				CUST	
EDIT	DATE	DESIGN	CHECK	DESCRIPTION	
DESIGN			CHECK	APPLY	FUJITSU TAKAMISAWA COMPONENT LIMITED
				24 / 80	

(2) Detection Functions

Detection Function	Function
Paper Run Out Detection	<ol style="list-style-type: none"> 1) During printing or feeding paper, a paper run out is detected when the sensor continuously detects a black level for about 6mm. 2) When the printer detects a paper run out during printing, and if currently printing data exists, the printer automatically enters off-line (BUSY) status after printing one line. 3) Set the paper. If an error has not occurred, one line is fed and printing restarts from the next line. 4) When paper run out detection invalid mode is set by the detection function setting command or the *SLCTIN pin, paper run out is not detected. 5) When paper run out status is detected in paper run out detection valid mode, paper cannot be fed by command, but can be fed by the *ATF signal. 6) When paper run out is detected, driving of the motor is turned OFF. 7) When the connector for detection is in open status, it is judged as a paper run out.
Platen Release Detection	<ol style="list-style-type: none"> 1) When the printer detects head up (platen open) during printing, the printer stops driving the head and the motor in one line unit, and the printer automatically enters off-line (BUSY) status. 2) Move the head down. If an error has not occurred, one line is fed and printing restarts from the next dot line. At this time printing continuity is not guaranteed. 3) When the head up (platen open) detection invalid mode is set by the detection function setting command or by the *SLCTIN pin, head up (platen open) is not detected. 4) When head up (platen open) status is detected in head up (platen open) detection valid mode, paper cannot be fed by command, but can be fed by the *ATF signal. 5) When head up (platen open) is detected, driving the motor is turned OFF.
Thermal Head Temperature Abnormality Detection	<ol style="list-style-type: none"> 1) Temperature is detected by the thermistor inside the thermal head to protect the head from heating. 2) When abnormal temperature (high temperature) is detected, the printer stands by in busy status until the temperature drops to the specified temperature. 3) When the temperature abnormality detection invalid mode is set by the detection function setting command or by the *SLCTIN pin, abnormal temperature is not detected. 4) When temperature abnormality is detected in temperature abnormality detection valid mode, paper cannot be fed by command. 5) When the temperature of the thermal head returns to printing enable status and an error has not occurred, the printer immediately returns to normal status.

A

B

C

D

A

B

C

D

E

F

DATE	↑	SECTION
		CONTROL
DATE		SECTION

					TITLE FTP-628DCL30X Series Product Specification	
					DRAW No. A1NA21207-3011/6	
					CUST	
EDIT	DATE	DESIGN	CHECK	DESCRIPTION		
DESIGN			CHECK	APPLY	FUJITSU TAKAMISAWA COMPONENT LIMITED	
					25 / 80	

A

B

C

D

A

B

C

D

E

F

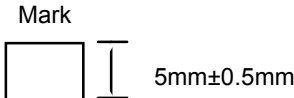
Detection Function	Function
Fuse Blow Out Detection	1) When a fuse blow out for motor protection is detected, the printer automatically enters off-line (BUSY) status. 2) Shut the power OFF and exchange the fuse. 3) In fuse blow out status, data cannot be received and paper cannot be fed by the *ATF signal.
Voltage Abnormality Detection	1) Printing head drive voltage is detected, when this voltage is not in 3.6V- 9.8V range voltage abnormality is detected and the printer automatically enters off-line status. 2) When power-supply voltage returns within the above-mentioned range and an error has not occurred, the printer immediately returns to normal status. 3) When the voltage abnormality detection invalid mode is set by the detection function setting command or by the *SLCTIN pin, abnormal voltage is not detected.
Cutter Abnormality Detection	1) In the cutting operation, if one cutting cycle is not end within 4 seconds, cutter abnormality is detected and the printer automatically enters off-line status. 2) When power-supply voltage returns or a hardware reset is executed, the printer returns to normal status. 3) In initialization, when the blade of cutter is not in the home position, the cutter is automatically moved in the home position. 4) This detection is effective when cutter enable mode is set by CSEL signal. 5) If the printer without a cutter receives a paper cut command, a hardware abnormality is sent after about 4 seconds.
Mark Detection Function	1) Mark is detected by the paper run out detection sensor. 2) The shape of the mark is as follows. <div style="text-align: center;">  <p>Mark 5mm±0.5mm</p> </div> 3) When paper run out or head down status is detected at initialization, the sensor may be on the mark. Feed paper for a maximum of 8 mm and stop the printer avoiding the mark position. If paper run out status is not cleared, it is judged as paper run out status and the printer stops. 4) If a mark is not detected on the page when mark detection is executed, mark undetected status is reported. 5) Mark undetected status is held until the next data (command) is received or until a high priority error occurs.
MCU Operation Abnormality Detection Function	1) MPU operation abnormality is detected by the watchdog timer to prevent printer damage caused by a malfunction. 2) If the watchdog timer is activated by MCU runaway, a hardware reset is executed automatically and printing stops. 3) When this condition is detected, a hardware abnormality is sent.

DOCUMENT CONTROL SECTION	↑
	DATE

					TITLE FTP-628DCL30X Series Product Specification	
					DRAW No. A1NA21207-3011/6	
					CUST	
EDIT	DATE	DESIGN	CHECK	DESCRIPTION		
DESIGN			CHECK	APPLY	FUJITSU TAKAMISAWA COMPONENT LIMITED	
					26 / 80	

(3) Protective Functions

Power Supply Disconnection Sequence Protection	<p>1) This function prevents burning of the head caused by the reverse order disconnection of the logic power supply and power supply for the head.</p> <p>2) By the thing to put up FET outside, even the logic power supply turning on cuts the head power supply, and the head is protected.</p> <p>3) MCU detects the head power supply voltage and fuse voltage at initialization, and stops initialization until these values reach the specified values.</p>
Motor Protection	<p>1) Insert a rush resistant fuse (capacity 1.0A) to prevent motor smoking caused by an operation abnormality.</p> <p>2) Motor current is shut OFF about ten seconds after the motor stops.</p>
Hardware Timer	<p>1) Limit the applied pulse width of the head by a hardware timer to prevent head burning by fixing the logic of the thermal head enable pin.</p>
Motor Power Save Function	<p>1) After the motor operation stops, current flows for one phase to maintain the phase of the pulse motor. This takes about 10 seconds. Current automatically shuts OFF. Motor excitation maintenance time can set by command.</p> <p>2) If current is OFF when motor operation starts, current flows in the same phase for a maximum of 50 ~ 60 msec to fix the pulse motor phase before motor operation starts.</p>
Power Down Function	<p>1) By receiving DC2 command, the printer switches to power down mode.</p> <p>2) In the state of the down of power, oscillation of departure pendulum is stopped.</p> <p>3) Please refer to the paragraph of control command specification for details of the power down function.</p>
Head Automatic Division Function	<p>1) By setting the printing speed automatic setting command, according to the ratio printed blacking driving division of the head is automatically done, and the battery drive is enabled.</p>
Head Width Automatic Detection Function	<p>1) In turning on the power or initialization by *INPRM signal the head width is automatically detected.</p> <p>2) If a printer detected the head width is 2 inch, MECO signal is set to "High". And if a printer detected the head width is 3 inch, MECO signal is set to "Low".</p>

DATE	
	↑
DOCUMENT CONTROL SECTION	

					TITLE FTP-628DCL30X Series Product Specification	
					DRAW No. A1NA21207-3011/6	
					CUST	
EDIT	DATE	DESIGN	CHECK	DESCRIPTION		
DESIGN			CHECK	APPLY	FUJITSU TAKAMISAWA COMPONENT LIMITED	
					27 / 80	

SECTION G Command Specification

A

Conventions for command explanations

Each command is explained using the following conventions:

[Name] Command name

[Function] Function of command

[Code] Control code represented in hexadecimal or decimal notation.
[X]₁₆ Hexadecimal notation
[X]₁₀ Decimal notation

[Explanation]

Explanation of command function

B

C

D

DATE	↑	DOCUMENT	CONTROL	SECTION

					TITLE		FTP-628DCL30X Series Product Specification	
					DRAW No.		A1NA21207-3011/6	
							CUST	
EDIT	DATE	DESIGN	CHECK	DESCRIPTION		FUJITSU TAKAMISAWA COMPONENT LIMITED		28 / 80
DESIGN			CHECK		APPLY			

(1) HT

[Name] Horizontal tab

[Function]

The HT command moves the printing position to the next horizontal tab position.

[Code] [09]₁₆
[09]₁₀

[Explanation]

- (1) If the next horizontal tab position is not set, the HT command is ignored.
- (2) If the next horizontal tab position is outside the printing area, the printing position is shifted to the proper position by adding 1 to the printing area width.
- (3) If an HT command is received when the print head is located at the position to which the printing has been newly shifted by adding 1 to the printing area width, buffer-full printing is executed. Then, the horizontal tab operation is executed from the head of the next line.
- (4) The horizontal tab position is set with *ESC D*.
- (5) If characters are received when the print head is located at the position to which the printing has been shifted by adding 1 to the printing area width, buffer-full printing is executed. Then, the print head moves to the leftmost column on the next line, and the received characters are processed. When a line feed command such as *LF* is received, data is printed and a line is fed. The print head then moves to the leftmost column on the next line.
- (6) In backward printing, the tab indicates a position from the rightmost column.

A

B

C

D

A

B

C

D

E

F

DATE	SECTION
	↑

					TITLE		FTP-628DCL30X Series Product Specification	
					DRAW No.		A1NA21207-3011/6	
							CUST	
EDIT	DATE	DESIGN	CHECK	DESCRIPTION		FUJITSU TAKAMISAWA COMPONENT LIMITED		29 / 80
DESIGN			CHECK		APPLY			

(2) LF

[Name] Line feed

[Function]

The LF command prints the data already contained in the print buffer, then sets the next-data receive position at the leftmost column on the next line.

[Code] [0A]₁₆
[10]₁₀

[Explanation]

- (1) The LF command prints the data already contained in the print buffer, then sets the next-data receive position at the leftmost column on the next line.
- (2) In the initial state, the line spacing is set to approx. 1/8 inch.
- (3) When there is no data in the print buffer, only a line feed operation is executed.
- (4) When different-height character typefaces are to be printed on the same line, these character typefaces are arranged so that their bottom ends are aligned at the same level.
- (5) If line spacing during printing/line-feeding is shorter than the character height, a length equal to the character height feeds the paper.

A

B

C

D

A

B

C

D

E

F

DATE	DOCUMENT CONTROL SECTION
	↑

					TITLE		FTP-628DCL30X Series Product Specification	
					DRAW No.		A1NA21207-3011/6	
							CUST	
EDIT	DATE	DESIGN	CHECK	DESCRIPTION		FUJITSU TAKAMISAWA COMPONENT LIMITED		30 / 80
DESIGN			CHECK		APPLY			

(3) FF

[Name] Forms feed (new page)

[Function]

The FF command prints the data already contained in the print buffer, then sets the next-data receive position at the leftmost column on the next page.

[Code] [0C]₁₆
[12]₁₀

[Explanation]

- (1) The *FF* command feeds paper by the specified page length.
- (2) In the initial state, the page length is set to approx. 143 mm. (44 lines).
- (3) When cut-sheet printing is selected, the *FF* command executes the following operations:
 - When the page length is set to 0 (page length cancellation) by using *ESC C*, the paper is ejected.
 - Paper ejection is checked using the paper-out sensor. When the detection is invalid, the paper ejection is checked.
 - The maximum paper ejection length is approx. 1 m. If the paper-out state is not detected within the span of the 1-meter ejection, the paper ejection terminates.
- (4) When label printing is selected, the *FF* command executes the following operations:
 - The data contained in the print buffer is printed, and a search is made for the head of the next label.
 - The beginning of a line is set as the next printing position.
 - A label is selected with *ESC c1*.

A

B

C

D

A

B

C

D

E

F

DATE	SECTION
	CONTROL
DOCUMENT	↑

					TITLE		FTP-628DCL30X Series Product Specification	
					DRAW No.		A1NA21207-3011/6	
							CUST	
EDIT	DATE	DESIGN	CHECK	DESCRIPTION				
DESIGN			CHECK		APPLY		FUJITSU TAKAMISAWA COMPONENT LIMITED	31 / 80

(4) DC2

[Name] Power down

[Function]

When it receives this command, the printer switches to power down mode.

[Code] [12]₁₆
[18]₁₀

[Explanation]

- (1) When receiving this code, the printer switches to power down mode.
- (2) If the printer buffer contains data, the printer prints the data before switching to power down mode. If the print buffer contains no data, the printer immediately switches to power down mode.
- (3) When level of *SLCTIN signal become low, power down mode is canceled.
- (4) If this code is received during printing, the printer switches to power down mode upon completion of the operation.
- (5) This code is invalid in bit image print mode.

A

B

C

D

A

B

C

D

E

F

DATE	↑
	DOCUMENT CONTROL SECTION

					TITLE		FTP-628DCL30X Series Product Specification	
					DRAW No.		A1NA21207-3011/6	
							CUST	
EDIT	DATE	DESIGN	CHECK	DESCRIPTION		FUJITSU TAKAMISAWA COMPONENT LIMITED		32 / 80
DESIGN			CHECK		APPLY			

(5) ESC RS

[Name] Black-white reversed printing specification

[Function]

The ESC RS command specifies black-white reversed printing.

[Code] [1B]₁₆ [1E]₁₆
[27]₁₀ [30]₁₀

[Explanation]

- (1) The ESC RS command specifies black-white reversed printing.
- (2) The ESC RS command can be specified in units expressed in characters. One line can contain both normal printed characters and reverse printed characters.
- (3) The ESC RS command can be used in all character modes.
- (4) The ESC RS command can also be used in bit image printing.
- (5) The line-spacing area is not appeared in reverse format.
- (6) When a printing start command (LF or FF) is received in reverse mode, some of the print image is not appear in reverse format. This reverse suppression continues from the reverse mode specified character to the rightmost column (in forward printing mode) or to the leftmost column (in backward printing mode).
- (7) The print image of the characters skipped with a HT command is not appear in reverse format.

A

B

C

D

A

B

C

D

E

F

DATE	↑	DOCUMENT	CONTROL	SECTION

					TITLE		FTP-628DCL30X Series Product Specification	
					DRAW No.		A1NA21207-3011/6	
							CUST	
EDIT	DATE	DESIGN	CHECK	DESCRIPTION				
DESIGN			CHECK		APPLY	FUJITSU TAKAMISAWA COMPONENT LIMITED		33 / 80

(6) ESC US

[Name] Black-white reversed printing cancellation

[Function]

The ESC US command cancels black-white reversed printing.

[Code] [1B]₁₆ [1F]₁₆
[27]₁₀ [31]₁₀

[Explanation]

- (1) The ESC US command cancels the reverse printing mode.
- (2) The ESC US command does not start character printing.

A

B

C

D

A

B

C

D

E

F

DATE	DOCUMENT CONTROL SECTION
	↑

					TITLE		FTP-628DCL30X Series Product Specification	
					DRAW No.		A1NA21207-3011/6	
							CUST	
EDIT	DATE	DESIGN	CHECK	DESCRIPTION				34 / 80
DESIGN			CHECK		APPLY		FUJITSU TAKAMISAWA COMPONENT LIMITED	

(7) ESC !+n

[Name] Printing mode specification

[Function]

The ESC !+n command specifies printing mode.

[Code] [1B]₁₆ [21]₁₆ [n]
[27]₁₀ [33]₁₀ [n]

[Explanation]

(1) The ESC !+n command specifies printing mode.

(2) The following figure shows the relationship between the bits of parameter n and printing mode:

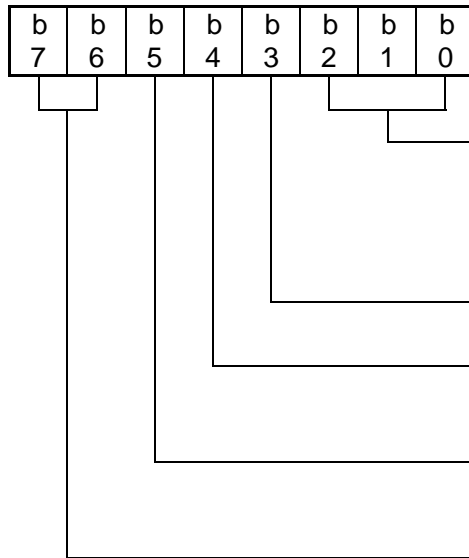

000: 08x16-dot ANK character typeface
 001: 12x24-dot ANK character typeface
 010: 16x16-dot ANK character typeface
 011: 24x24-dot ANK character typeface

Undefined

0: Double-width cancellation
 1: Double-width specification

0: Double-height cancellation,
 1: Double-height specification

Undefined

(3) When both the double width and double height are specified, characters with the double height and width character typeface are printed.

(4) When one line contains different-height character typefaces, the character typefaces are arranged so that their bottom ends are aligned at the same level.

DOCUMENT CONTROL SECTION

DATE

					TITLE		FTP-628DCL30X Series Product Specification	
					DRAW No.		A1NA21207-3011/6	
							CUST	
EDIT	DATE	DESIGN	CHECK	DESCRIPTION				
DESIGN			CHECK		APPLY	FUJITSU TAKAMISAWA COMPONENT LIMITED		35 / 80

(8) ESC %+n

[Name] External registration character specification/cancellation

[Function]

The ESC %+n command specifies or cancels registered external characters.

[Code] [1B]₁₆ [25]₁₆ [n]
[27]₁₀ [37]₁₀ [n]

[Explanation]

(1) The ESC %+n command selects an internal character set (system-defined font) or a registered external character set (user-defined font).

(2) The following figure shows the relationship between the bits of parameter n and the character set to be selected:

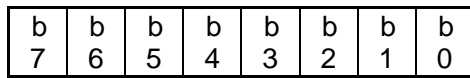

- 000: Internal character specification
- 001: Registered external character specification
- 010: Undefined
- 011: Undefined
- 100: Undefined
- 101: Undefined
- 110: Undefined
- 111: Undefined

Undefined

(3) One of the following character sets is selected with the character type selected with the ESC ! command:

No.	ESC ! Specification	Registered External Character Specification
1	08 x 16 ANK	08 x 16 registered
2	12 x 24 ANK	12 x 24 registered
3	16 x 16 ANK	16 x 16 registered
4	24 x 24 ANK	24 x 24 registered

(4) If an undefined external character code is received when the registered character-printing mode is set, the corresponding internal character is printed.

DOCUMENT CONTROL SECTION

DATE

					TITLE		FTP-628DCL30X Series Product Specification	
					DRAW No.		A1NA21207-3011/6	
							CUST	
EDIT	DATE	DESIGN	CHECK	DESCRIPTION				
DESIGN			CHECK		APPLY	FUJITSU TAKAMISAWA COMPONENT LIMITED		36 / 80

(9) ESC &+y+c1+c2+x+d1 to dN

[Name] External registration character definition

[Function]

The ESC &+y+c1+c2+x+d1 to dN command defines external characters to be registered.

[Code] [1B]₁₆ [26]₁₆ [y] [c1] [c2] [x] [d1] to [dN]
[27]₁₀ [38]₁₀ [y] [c1] [c2] [x] [d1] to [dN]

[Explanation]

- (1) This ESC command defines external characters to be registered.
- (2) Parameter y must specify 0.
- (3) Parameter x specifies a dummy code. A NUL code must be specified.
- (4) Parameter d specifies the data to be defined.
- (5) Parameter c1 and c2 specify the areas to be defined. The values of parameter c1 and c2 values must satisfy the following conditions:

$$[20]_{16} \quad c1 \quad c2 \quad [FF]_{16}$$

- (6) To define one character, parameter c1 and c2 must be specified so that the c1 value is equal to the c2 value. To define two or more characters, the data block of d1 to dN must be specified the same number of times as the number of characters to be defined.
- (7) If "c2 < c1" is detected, a parameter error is assumed and the external characters are not registered.
- (8) The length of the data required to define one external character to be registered depends on the character type specified with the ESC ! command (see the following table):

Character type specified with ESC !	Data length
08 x 16 ANK	16 bytes
12 x 24 ANK	48 bytes

- (9) The maximum number of registration characters is 8. If character registrations is executed over 8 characters, it's the parameter error.

DOCUMENT CONTROL SECTION

DATE

↑

					TITLE		FTP-628DCL30X Series Product Specification	
					DRAW No.		A1NA21207-3011/6	
							CUST	
EDIT	DATE	DESIGN	CHECK	DESCRIPTION				
DESIGN			CHECK		APPLY		FUJITSU TAKAMISAWA COMPONENT LIMITED	37 / 80

(9) The character-typeface definition data must use the following formats:

	MSB	LSB
d1		
d2		
d3		
d4		
d5		
d6		
d7		
d8		
d9		
d1		
0		
d11		
d1		
2		
d1		
3		
d1		
4		
d1		
5		
d1		
6		

[8×16]

	MSB	LSB	MSB	LSB	MSB	LSB
d1						
d4						
d7						
d1						
0						
d1						
3						
d1						
6						
d1						
9						
d2						
2						
d2						
5						
d2						
8						
d3						
1						
d3						
4						
d3						
7						
d4						
0						
d4						
3						
d4						
6						
d4						
9						
d5						
2						
d5						
5						
d5						
8						
d6						
1						
d6						
4						
d6						
7						
d7						
0						

[24×24]

DATE	↑
	DOCUMENT CONTROL SECTION

				TITLE		FTP-628DCL30X Series Product Specification	
				DRAW No.		A1NA21207-3011/6	
						CUST	
EDIT	DATE	DESIGN	CHECK	DESCRIPTION			
DESIGN			CHECK	FUJITSU TAKAMISAWA COMPONENT LIMITED		38 / 80	
				APPLY			

A

B

C

D

A

B

C

D

E

F

MSB LSB MSB LSB

d1									
d3									
d5									
d7									
d9									
d11									
d1									
3									
d1									
5									
d1									
7									
d1									
9									
d2									
1									
d2									
3									
d2									
5									
d2									
7									
d2									
9									
d3									
1									

[16x16]

MSB LSB MSB LSB

d1									
d3									
d5									
d7									
d9									
d11									
d1									
3									
d1									
5									
d1									
7									
d1									
9									
d2									
1									
d2									
3									
d2									
5									
d2									
7									
d2									
9									
d3									
1									
d3									
3									
d3									
5									
d3									
7									
d3									
9									
d4									
1									
d4									
3									
d4									
5									
d4									
7									

[12x24]

DATE	↑
DOCUMENT CONTROL SECTION	

				TITLE		FTP-628DCL30X Series Product Specification	
				DRAW No.		A1NA21207-3011/6	
						CUST	
EDIT	DATE	DESIGN	CHECK	DESCRIPTION			
DESIGN			CHECK	FUJITSU TAKAMISAWA COMPONENT LIMITED		39 / 80	
				APPLY			

(10) ESC **+m+n1+n2+d1 to dN*

[Name] Bit image printing

[Function]

The ESC **+m+n1+n2+d1 to dN* command specifies and prints a bit image.

[Code] [1B]₁₆ [2A]₁₆ [m] [n1] [n2] [d1] to [dN]
[27]₁₀ [42]₁₀ [m] [n1] [n2] [d1] to [dN]

[Explanation]

(1) This *ESC* command specifies and prints a bit image.

(2) The relationship between parameter *m* and image print modes is as follows:

m	Mode	Number of print dots		Number of dots
		Vertical direction (number of dots)	Horizontal Direction	
97	Single density	1	16	$(n2*256+n1)*print-width/2$
98	Double density	1	8	$(n2*256+n1)*print-width$

(3) Parameter *n1* and *n2* specify the number of lines to be printed. Without regard to the specified mode, conditions $0 \leq n1 \leq 255$ and $0 \leq n2 \leq 3$ must be satisfied. If condition $n1 = n2 = 0$ is satisfied, a parameter error is assumed and this *ESC* command becomes invalid. Data overflowing from the specified printing area is ignored.

(4) The following figure shows the relationship between bit image data and print data:

- When $m = 97$

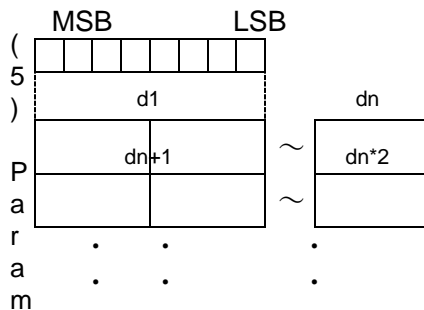

- When $m = 98$

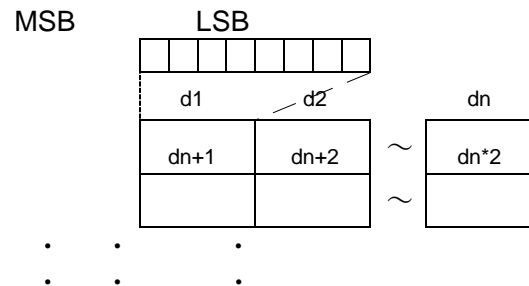

(5) Parameter *n1* and *n2* specify the number of dots in the vertical direction of the bit image to be printed. That is, the number of dots is " $256 \times n2 + n1$." Therefore, the number of dots to be transferred is " $(256 \times n2 + n1) \times print-head-width$."

(6) The print width depends on the printer model as follows:

Printer	Print width (bytes)
FTP-628MCL	48
FTP-638MCL	72

DOCUMENT CONTROL SECTION

DATE

				TITLE	FTP-628DCL30X Series Product Specification		
				DRAW No.	A1NA21207-3011/6		CUST
EDIT	DATE	DESIGN	CHECK	DESCRIPTION		FUJITSU TAKAMISAWA COMPONENT LIMITED	40/80
DESIGN			CHECK	APPLY			

(11) ESC ?+n

[Name] External registration character deletion

[Function]

The ESC ?+n command deletes an external registration character specified with parameter n

[Code] [1B]₁₆ [3F]₁₆ [n]
[27]₁₀ [63]₁₀ [n]

[Explanation]

The character code registered is deleted. The value of parameter n must satisfy the following condition:

$$[20]_{16} \leq n \leq [FF]_{16}$$

- (2) After deletion, the corresponding internal character is printed.
- (3) The code definition pattern of the character type specified with the ESC ! command is deleted.
- (4) If an unregistered character code is specified with the ESC ?+n command, the ESC ?+n command is ignored.

A

B

C

D

A

B

C

D

E

F

DATE	↑
	DOCUMENT CONTROL SECTION

					TITLE		FTP-628DCL30X Series Product Specification	
					DRAW No.		A1NA21207-3011/6	
							CUST	
EDIT	DATE	DESIGN	CHECK	DESCRIPTION		FUJITSU TAKAMISAWA COMPONENT LIMITED		41 / 80
DESIGN			CHECK		APPLY			

(12) ESC 2

[Name] 1/6-inch line pitch setting

[Function]

The ESC 2 command sets the single line pitch to 1/6 inch.

[Code] [1B]₁₆ [32]₁₆
[27]₁₀ [50]₁₀

[Explanation]

(1) The ESC 2 command sets single line pitch to 1/6 inch.

(2) When line pitch is set using the ESC 2 command, the line spacing set with the ESC A command is invalidated.

A

B

C

D

A

B

C

D

E

F

DATE	↑	DOCUMENT CONTROL SECTION

					TITLE		FTP-628DCL30X Series Product Specification	
					DRAW No.		A1NA21207-3011/6	
							CUST	
EDIT	DATE	DESIGN	CHECK	DESCRIPTION				
DESIGN			CHECK		APPLY	FUJITSU TAKAMISAWA COMPONENT LIMITED		42 / 80

(13) ESC 3+n

[Name] Line pitch setting

[Function]

The ESC 3+n command sets single line pitch.

[Code] [1B]₁₆ [33]₁₆ [n]
[27]₁₀ [51]₁₀ [n]

[Explanation]

- (1) The ESC 3+n command sets single line pitch to n dot lines.
- (2) When line pitch is set using the ESC 3+n command, the line pitch previously set with the ESC A command is invalidated.
- (3) In line feed with printing, paper is fed by at least the height of the character currently specified. In line feed without printing, paper is fed only by the specified line spacing. For example, when line spacing of 10 dot lines is specified for a character of which height is 24 dot lines, paper is fed by 24 dot lines (in line feed with printing) or 10 dot lines (in line feed without printing).

A

B

C

D

A

B

C

D

E

F

DOCUMENT CONTROL SECTION	↑
	DATE

					TITLE		FTP-628DCL30X Series Product Specification	
					DRAW No.		A1NA21207-3011/6	
							CUST	
EDIT	DATE	DESIGN	CHECK	DESCRIPTION		FUJITSU TAKAMISAWA COMPONENT LIMITED		43 / 80
DESIGN			CHECK		APPLY			

(14) ESC @

[Name] Printer resetting

[Function]

The ESC @ command initializes the printer.

[Code] [1B]₁₆ [40]₁₆
[27]₁₀ [64]₁₀

[Explanation]

- (1) The ESC @ command initializes the printer.
- (2) The ESC @ command prints the data contained in the print buffer, and initializes various setup items.
- (3) When the ESC @ command is executed, various setup items are set as follows:
 - (a) Print buffer = Cleared
 - (b) Line pitch = 26 dot lines
 - (c) Type of print characters = 12x24-dot ANK
 - (d) Double-width character printing specification = Cancellation
 - (e) Double-height character printing specification = Cancellation
 - (f) Character code set = Domestic character set
 - (g) International character set = Japan
 - (h) Mark head detection distance setting = Approx. 2 mm (forward direction)
 - (i) Paper-out detection function = Valid^{*1}
 - (j) Head up (platen open) detection function = Valid^{*1}
 - (k) Thermal error detection function = Valid^{*1}
 - (l) Voltage error detection function = Valid^{*1}
 - (m) Print quality = Standard paper
 - (n) X4 size print mode specification = Clear
 - (o) Printing speed setting = High-speed mode
 - (p) Receive code buffer = Retained
 - (q) Horizontal tab setting = Every 8 characters
 - (r) Reverse video specification = Cancellation
 - (s) Backward printing specification = Cancellation
 - (t) Feed function = Valid
 - (u) Paper type = Continuous forms
 - (v) Registered characters = Retained
 - (w) Page length setting = 44 lines (approx. 143 mm)
 - (x) 90° character rotation = Clear
 - (y) Paper auto-feed amount setting = 20mm
 - (z) Motor off-time setting = One excitation time : 0.5 sec
Excitation holding time : 1 sec
 - (aa) Automatic operation division print setting = Cancellation

*1: This can be set to invalid by the *SLCTIN signal.

DOCUMENT CONTROL SECTION

DATE

					TITLE		FTP-628DCL30X Series Product Specification	
					DRAW No.		A1NA21207-3011/6	
							CUST	
EDIT	DATE	DESIGN	CHECK	DESCRIPTION				
DESIGN			CHECK		APPLY	FUJITSU TAKAMISAWA COMPONENT LIMITED		44 / 80

(15) ESC A+n

[Name] Line spacing setting

[Function]

The ESC A+n command sets the line spacing to "n" dot lines.

[Code] [1B]₁₆ [41]₁₆ [n]
[27]₁₀ [65]₁₀ [n]

[Explanation]

- (1) The ESC A+n command sets the line spacing to "n" dot lines.
- (2) Condition 0 n 255 must be satisfied. However, when "n + character-height" is 256 dot lines or more, the line spacing is n + character-height - 256.
- (3) If the ESC A+n command is set two or more times for the same line, the last set line spacing is valid.
- (4) When line pitch is set with the ESC 3 or ESC 2 command, the line spacing set with the ESC A+n is invalidated.

A

B

C

D

A

B

C

D

E

F

DATE	↑
	DOCUMENT CONTROL SECTION

					TITLE		FTP-628DCL30X Series Product Specification	
					DRAW No.		A1NA21207-3011/6	
							CUST	
EDIT	DATE	DESIGN	CHECK	DESCRIPTION				
DESIGN			CHECK		APPLY	FUJITSU TAKAMISAWA COMPONENT LIMITED		45 / 80

(16) ESC C+n

[Name] Page length setting

[Function]

The ESC C+n command sets the page length to "n" lines.

[Code] [1B]₁₆ [43]₁₆ [n]
[27]₁₀ [67]₁₀ [n]

[Explanation]

- (1) The ESC C+n command sets the page length to "n" lines.
- (2) Condition 0 n 63 must be satisfied.
- (3) When parameter n specifies 0, the page length is reset. If a FF command is received when the cut sheet mode is specified and the page length is reset, the paper is ejected.
- (4) If the value of parameter n is incorrect, the page length setting is invalidated and the previous page length is validated.
- (5) Even if the line spacing is changed after the page length is set, the page length is not changed.
- (6) When an ESC C+n command is executed, the printing start position moves to the top of the next page.
- (7) The line pitch is set as follows:
 - (a) When the line spacing is set with ESC A command, the line pitch is set with "character-height + line spacing".
 - (b) When the line pitch is set with ESC 2 or ESC 3 command, the line pitch is set with the line pitch to be set.

A

B

C

D

A

B

C

D

E

F

DATE	↑	DOCUMENT	CONTROL	SECTION

					TITLE		FTP-628DCL30X Series Product Specification	
					DRAW No.		A1NA21207-3011/6	
							CUST	
EDIT	DATE	DESIGN	CHECK	DESCRIPTION				
DESIGN			CHECK		APPLY	FUJITSU TAKAMISAWA COMPONENT LIMITED		46 / 80

(17) ESC D+d1 to dN+NUL

[Name] Horizontal tab position setting

[Function]

The ESC D+d1 to dN+NUL command sets the horizontal tab position.

[Code] [1B]₁₆ [44]₁₆ [d1] to [dN] [00]₁₆
[27]₁₆ [68]₁₆ [d1] to [dN] [00]₁₀

[Explanation]

- (1) Condition $1 \leq d \leq 255$ must be satisfied.
- (2) Condition $1 \leq N \leq 32$ must be satisfied.
- (3) The horizontal tab position is set to the position that is "d x ank-character-width" distant from the head of the line in the printing area.
When character-width are satisfied to double-width, the horizontal tab position is applied double- character width.
- (4) Even if the character width is changed after the horizontal tab position is set, the set horizontal tab position is not changed.
- (5) When the horizontal tab is set with the ESC D+d1 to dN+NUL command, the horizontal tab position already set is canceled.
- (6) When horizontal position d=8 is set, executing a HT command moves the next print position to column 9.
- (7) Up to 32 horizontal tab positions can be set. If more than 32 horizontal tab positions are set, the data at the excessive tab positions is handled as ordinary data.
- (8) The "d" values must be entered in ascending order, and must end with NUL. If the "dN" value is equal to or smaller than the "dN-1" value, processing this ESC command is terminated when the dN value is received. The subsequent data is handled as ordinary data.
- (9) All horizontal tab positions can be canceled with the ESC D NUL command.
- (10) When the power to the printer is turned on or the printer is reset, the horizontal tab positions are set for intervals of 8 characters selected in the initial state.

DATE	DOCUMENT CONTROL SECTION	↑

					TITLE		FTP-628DCL30X Series Product Specification	
					DRAW No.		A1NA21207-3011/6	
							CUST	
EDIT	DATE	DESIGN	CHECK	DESCRIPTION				
DESIGN			CHECK		APPLY	FUJITSU TAKAMISAWA COMPONENT LIMITED		47 / 80

(18) ESC J+n

[Name] Forward paper feed

[Function]

The ESC J+n command feeds paper in the forward direction.

[Code] [1B]₁₆ [4A]₁₆ [n]
[27]₁₀ [74]₁₀ [n]

[Explanation]

- (1) The ESC J+n command feeds paper in the forward direction by "n" dot lines.
- (2) Condition 0 ≤ n ≤ 255 must be satisfied.
- (3) When there is data in the print buffer, the data in the print buffer is printed after which paper is fed in the forward direction.
- (4) When parameter n specifies 0, the data contained in the buffer is printed but paper is not fed.

A

B

C

D

A

B

C

D

E

F

DATE	↑
	DOCUMENT CONTROL SECTION

					TITLE		FTP-628DCL30X Series Product Specification	
					DRAW No.		A1NA21207-3011/6	
							CUST	
EDIT	DATE	DESIGN	CHECK	DESCRIPTION		FUJITSU TAKAMISAWA COMPONENT LIMITED		48 / 80
DESIGN			CHECK		APPLY			

(19) ESC K+n

[Name] Backward paper feed

[Function]

The ESC K+n command feeds paper in the backward direction.

[Code] [1B]₁₆ [4B]₁₆ [n]
[27]₁₀ [75]₁₀ [n]

[Explanation]

(1) The ESC K+n command feeds paper in the backward direction by "n" dot lines.

Condition $0 \leq n \leq 255$ must be satisfied.

(3) When there is data in the print buffer, the data in the print buffer is printed after which paper is fed in the backward direction.

(4) When parameter n specifies 0, the data contained in the buffer is printed but paper is not fed.

(5) If paper back-feed is executed, paper jam may be occurred. If use this command, it is necessary to confirm application with printer.

(6) if paper back-feed executed, the upper part of character is smashed by gear's back-rush. When the print is execute after back-feeding, feed the paper forward with amount more than back-rush, prevent smash of character.

(7) When this command is executed, the paper must not come off from the rubber roller.

A

B

C

D

A

B

C

D

E

F

DATE	↑	DOCUMENT	CONTROL	SECTION

					TITLE		FTP-628DCL30X Series Product Specification	
					DRAW No.		A1NA21207-3011/6	
							CUST	
EDIT	DATE	DESIGN	CHECK	DESCRIPTION				
DESIGN			CHECK		APPLY	FUJITSU TAKAMISAWA COMPONENT LIMITED		49 / 80

(20) ESC R+n

[Name] International character specification

[Function]

The ESC R+n command specifies printing using a specified set of international characters.

[Code] [1B]₁₆ [52]₁₆ [n]
[27]₁₀ [82]₁₀ [n]

[Explanation]

- (1) The ESC R+n command enables a set of international characters (specified with parameter n) to be printed.
- (2) The relationship between international characters and parameter n is as shown below.
- (3) In the initial state, the domestic character set and character set "Japan" are set.
- (4) If the value of parameter n is invalid, this ESC command is invalidated. The previous setting is validated.

n	Code Country	23	24	40	5B	5C	5 D	5D	5E	60	7B	7C	7E
0	USA	#	\$	@	[\]	^	`	{		}	~
1	FRENCH	#	\$	à	°	ç	§	^	`	é	ù	è	¨
2	GERMAN	#	\$	§	Ä	Ö	Ü	^	`	ä	ö	ü	ß
3	UK	£	\$	@	[\]	^	`	{		}	~
4	DENMARK	#	\$	@	Æ	Ø	Å	^	`	æ	ø	å	~
5	SWEDEN	#	¤	É	Ä	Ö	Å	Ü	é	ä	ö	å	ü
6	ITALY	#	\$	@	°	\	é	^	ù	à	ò	è	ì
7	SPAIN	Pt	\$	@	í	Ñ	¿	^	`	¨	ñ	}	~
8	JAPAN	#	\$	@	[¥]	^	`	{		}	-
9	NORWAY	#	¤	É	Æ	Ø	Å	Ü	é	æ	ø	å	ü
10	DENMARK2	#	\$	É	Æ	Ø	Å	Ü	é	æ	ø	å	ü
11	SPAIN2	#	\$	á	í	ñ	¿	é	`	í	ñ	ó	ú
12	RATIN AMERICA	#	\$	á	í	ñ	¿	é	Ü	í	ñ	ó	ú
13	JAPAN2	#	\$	@	[¥]	^	`	{		}	~

(Each code value is represented in hexadecimal notation.)

n = [41]₁₆ Domestic character set ANK

n = [42]₁₆ Foreign character set ANK

DOCUMENT CONTROL SECTION

DATE

				TITLE		FTP-628DCL30X Series Product Specification	
				DRAW No.		A1NA21207-3011/6	
						CUST	
EDIT	DATE	DESIGN	CHECK	DESCRIPTION			
DESIGN			CHECK		APPLY	FUJITSU TAKAMISAWA COMPONENT LIMITED	
						50 / 80	

(21) ESC c+1+n

[Name] Internal processing setting

[Function]

The ESC c+1+n command sets internal processing.

[Code] [1B]₁₆ [63]₁₆ [31]₁₆ [n]
[27]₁₀ [99]₁₀ [49]₁₀ [n]

[Explanation]

(1) The bits of parameter n specify internal processing as follows:

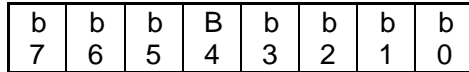

- 0: Continuous forms
- 1: Labels
- 2: Cut sheets
- 3: Continuous forms with auto paper load Function
- Undefined
- In moved the head down
 - 0: auto paper load effective
 - 1: auto paper load Invalidity
- 0: Forward detection of marks (fixing)
- Undefined
- 0: Mark detection selection (fixing)

(2) A mark is a black bar with a height of 5 mm.

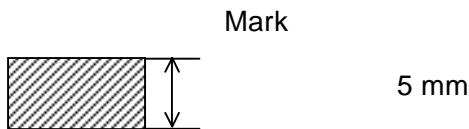

- (3) When the printer is initialized, parameter n is cleared to 0.
- (4) If this ESC command is issued when there is data in the print buffer, the data in the buffer is printed after which the internal processing is set.
- (5) When the specified paper type is a label, marks are automatically detected when forms are inserted. When the specified paper type is cut sheets, cut sheets are automatically fed when they are set.
- (6) If the paper type is changed from "cut sheets" to "other than cut sheets," the existing forms are automatically ejected.
- (7) When the specified paper type is continuous forms with auto paper load, continuous forms with auto paper load are automatically fed when they are set.

DOCUMENT CONTROL SECTION

DATE

				TITLE		FTP-628DCL30X Series Product Specification	
				DRAW No.		A1NA21207-3011/6	
						CUST	
EDIT	DATE	DESIGN	CHECK	DESCRIPTION			
DESIGN			CHECK		APPLY		
FUJITSU TAKAMISAWA COMPONENT LIMITED						51 / 80	

(22) ESC d+n

[Name] n-line feed

[Function]

The ESC d+n command prints the data and feeds a line, then feeds the paper by "n" lines.

[Code] [1B]₁₆ [64]₁₆ [n]
[27]₁₀ [100]₁₀ [n]

[Explanation]

- (1) The *ESC d+n* command feeds paper by a line count specified with parameter n.
- (2) Condition 0 n 255 must be satisfied.
- (3) After "n" lines are fed, the data receive position is set at the left edge on the line.
- (4) When the value of parameter n is 0, the data contained in the buffer is printed but the paper is not fed.
- (5) When there is data in the print buffer, the data contained in the buffer is printed after which paper is fed by "n" lines.

A

B

C

D

A

B

C

D

E

F

DOCUMENT CONTROL SECTION	↑
	DATE

					TITLE		FTP-628DCL30X Series Product Specification	
					DRAW No.		A1NA21207-3011/6	
							CUST	
EDIT	DATE	DESIGN	CHECK	DESCRIPTION		FUJITSU TAKAMISAWA COMPONENT LIMITED		52 / 80
DESIGN			CHECK		APPLY			

(23) ESC e+n

[Name] Backward n-line feed

[Function]

The ESC e+n command prints the data and feeds a line, then feeds the paper in the backward direction by "n" lines.

[Code] [1B]₁₆ [65]₁₆ [n]
[27]₁₀ [101]₁₀ [n]

[Explanation]

- (1) The ESC e+n command feeds paper in the backward direction by the line count specified with parameter n.
- (2) Condition 0 n 255 must be satisfied.
- (3) After "n" lines are fed, the data receive position is set at the left edge on the line.
- (4) When the value of parameter n is 0, the data contained in the buffer is printed but the paper is not fed.
- (5) If paper back-feed is executed, paper jam may be occurred. If use this command, it is necessary to confirm application with printer.
- (6) if paper back-feed executed, the upper part of character is smashed by gear's back-rush. When the print is execute after back-feeding, feed the paper forward with amount more than back-rush, prevent smash of character.
- (7) When this command is executed, the paper must not come off from the rubber roller.

A

B

C

D

A

B

C

D

E

F

DOCUMENT CONTROL SECTION	↑
	DATE

					TITLE FTP-628DCL30X Series Product Specification	
					DRAW No. A1NA21207-3011/6	
					CUST	
EDIT	DATE	DESIGN	CHECK	DESCRIPTION		
DESIGN			CHECK	APPLY	FUJITSU TAKAMISAWA COMPONENT LIMITED	
					53 / 80	

(24) ESC s+n

[Name] Printing speed setting

[Function]

The ESC s+n command sets printing speed.

[Code] [1B]₁₆ [73]₁₆ [n]
[27]₁₀ [115]₁₀ [n]

[Explanation]

- (1) The ESC s+n command sets printing speed (function mode).
- (2) When there is data in the print buffer, the data contained in the print buffer is printed after which the printing speed is set.
- (3) When the same printing speed as the current printing speed is specified with this ESC command, no change occurs.
- (4) The relationship between parameter n and the specified printing speed is as follows:

n	Function mode
[60] ₁₆	High-speed printing
[61] ₁₆	Medium-speed printing
[62] ₁₆	Medium-speed printing
[63] ₁₆	Low-speed printing
[64] ₁₆	Fixed division into six printing (628 series)
	Fixed division into nine printing (638 series)

- (5) If a parameter value not listed in the above table is set, the newly set printing speed is invalidated. The previous printing speed is validated.

DATE	
DOCUMENT CONTROL SECTION	↑

					TITLE	FTP-628DCL30X Series Product Specification	
					DRAW No.	A1NA21207-3011/6	CUST
EDIT	DATE	DESIGN	CHECK	DESCRIPTION			
DESIGN			CHECK		APPLY		54 / 80

(25) ESC t+n

[Name] Character code table selection

[Function]

The ESC t+n command selects page n from the character code table.

[Code] [1B]₁₆ [74]₁₆ [n]
[27]₁₀ [116]₁₀ [n]

[Explanation]

(1) The ESC t+n command selects page n from the character code table.

(2) The bits of parameter n specify the following information:

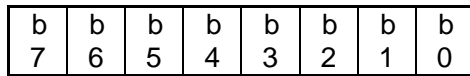

0: National character setting
1: Overseas character setting

Undefined

(3) The ESC t+n command has the same effect as that acquired by specifying [41]₁₆ or [42]₁₆ in the parameter of the ESC R command. Therefore, when both the ESC t+n command and the ESC R command are specified, the last of these ESC commands specified is validated.

(4) The initial value of parameter n is 0.

(5) See Section H, "List of Character Codes."

DATE	↑	SECTION
		CONTROL
DOCUMENT		

					TITLE		FTP-628DCL30X Series Product Specification	
					DRAW No.		A1NA21207-3011/6	
							CUST	
EDIT	DATE	DESIGN	CHECK	DESCRIPTION				
DESIGN			CHECK		APPLY	FUJITSU TAKAMISAWA COMPONENT LIMITED		55 / 80

(26) ESC {+n

[Name] Upside-down printing setting/cancellation

[Function]

The ESC{+n command sets or cancels upside-down printing.

[Code] [1B]₁₆ [7B]₁₆ [n]
[27]₁₀ [123]₁₀ [n]

[Explanation]

- (1) Parameter n sets or cancels upside-down printing.
- (2) The bits of parameter n specify the following information:

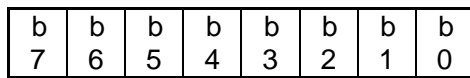

0: Upside-down printing cancellation
 1: Upside-down printing setting

Undefined

- (3) The ESC {+n command can be used in all character modes.
- (4) The ESC {+n command can also be used in bit image printing.
- (5) The character base line is at the bottom of the character typeface. Print character typefaces are arranged so that their bottom ends are aligned at the same level.

DATE	
DOCUMENT CONTROL SECTION	↑

				TITLE		FTP-628DCL30X Series Product Specification	
				DRAW No.		A1NA21207-3011/6	
						CUST	
EDIT	DATE	DESIGN	CHECK	DESCRIPTION			
DESIGN			CHECK		APPLY	FUJITSU TAKAMISAWA COMPONENT LIMITED	
						56 / 80	

(27) FS 9+n

[Name] Detection function enable/disable setting

[Function]

The FS 9+n command enables or disables various detection functions.

[Code] [1C]₁₆ [39]₁₆ [n]
[28]₁₀ [57]₁₀ [n]

[Explanation]

(1) Condition 0 n 255 must be satisfied.

(2) The bits of parameter n specify the following information:

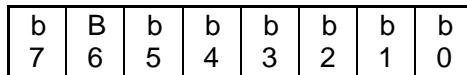

0: Feed key invalid
1: Feed key valid

0: Thermal error detection invalid
1: Thermal error detection valid

0: Voltage error detection invalid
1: Voltage error detection valid

0: Head up (platen open) detection invalid
1: Head up (platen open) detection valid

Undefined

Undefined

0: Paper-out detection invalid
1: Paper-out detection valid

Undefined

(3) In the initial state, all of the detection functions are valid.

(4) The voltage error detection valid or invalid setting enables or disables the fuse blow out detection function.

DATE DOCUMENT CONTROL SECTION

					TITLE		FTP-628DCL30X Series Product Specification	
					DRAW No.		A1NA21207-3011/6	
							CUST	
EDIT	DATE	DESIGN	CHECK	DESCRIPTION				
DESIGN			CHECK		APPLY	FUJITSU TAKAMISAWA COMPONENT LIMITED		57 / 80

(28) GS <

[Name] Mark detection execution

[Function]

The GS < command feeds paper up to the next mark position.

[Code] [1D]₁₆ [3C]₁₆
[29]₁₀ [60]₁₀

[Explanation]

- (1) The GS < command feeds paper up to the next mark position.
- (2) After a mark is detected, paper is fed (the head is detected) in accordance with the head detection base; the paper feed then stops.
- (3) In the initial state, the mark mode is set.
- (4) If no mark is found within the specified page length from the mark-detection-execution starting point, an error is assumed and the page feed stops.
- (5) For an explanation of the relationship between mark position and print line position, see the printer mechanism specifications.

A

B

C

D

A

B

C

D

E

F

DATE	↑	DOCUMENT CONTROL SECTION

					TITLE		FTP-628DCL30X Series Product Specification		
					DRAW No.		A1NA21207-3011/6		
							CUST		
EDIT	DATE	DESIGN	CHECK	DESCRIPTION				FUJITSU TAKAMISAWA COMPONENT LIMITED	58 / 80
DESIGN			CHECK		APPLY				

(29) GS A+m+n

[Name] After-mark-detection head distance setting

[Function]

The GS A+m+n command sets the head detection distance to be used after mark detection.

[Code] [1D]₁₆ [41]₁₆ [m] [n]
[29]₁₀ [65]₁₀ [m] [n]

[Explanation]

- (1) The GS A+m+n command sets the head detection distance to be used after mark detection.
- (2) The value of parameter m is always 0.
- (3) Parameter n specifies the head detection distance in dot lines.
- (4) Condition 0 ≤ n ≤ 63 must be satisfied. If an "n" value outside this range is specified, a parameter error occurs. The previous head detection distance is not changed.
- (5) When the power is turned on or the printer is reset, parameter m is cleared to 0 and parameter n is set to 16.

A

B

C

D

A

B

C

D

E

F

DATE	↑	DOCUMENT CONTROL SECTION

					TITLE		FTP-628DCL30X Series Product Specification	
					DRAW No.		A1NA21207-3011/6	
							CUST	
EDIT	DATE	DESIGN	CHECK	DESCRIPTION				
DESIGN			CHECK		APPLY	FUJITSU TAKAMISAWA COMPONENT LIMITED		59 / 80

(30) GS E+n

[Name] Print quality setting

[Function] The GS E+n command sets print quality in paper units.

[Code] [1D]₁₆ [45]₁₆ [n]
[29]₁₀ [69]₁₀ [n]

[Explanation]

- (1) The GS E+n command sets print quality for each paper and automatic division print mode is set or canceled.
 - (2) In most high-order bit n₇ of n, automatic division print mode is set or canceled. When parameter n₇ specifies 1, automatic division print mode is canceled. In this case the print speed conforms to setting by the print speed set command. When parameter n₇ specifies 0, automatic division print mode is set.
- If automatic division print mode is set, regardless of the print speed command (ESC s), driving division of the head is automatically executed according to the print rate of the printed data. Therefore, the printing speed changes by printing data.
- (4) The automatic division print mode is controlled by the energizing dot number 64 dots at the maximum.
 - (5) The four low-order bits of parameter n are used to select paper quality. The relationship between parameter n and paper quality is as follows:

n	Mode	Paper quality	Applicable paper type	Manufacturer
0	TYPE[1]			
1	TYPE[2]			
2	TYPE[3]		TF50KS-E4	Nippon Paper Mfg. Co., Ltd.
3	TYPE[4]	Standard paper	PD15R, PD160R, PD170R	Oji Paper Mfg. Co., Ltd.
4	TYPE[5]		TF60KS-F1, TF60KJ-R	Nippon Paper Mfg. Co., Ltd.
5	TYPE[6]		TF60KS-E	Nippon Paper Mfg. Co. Ltd.
			P220VBB-1	Mitsubishi Paper Mills, Ltd.
6	TYPE[7]		HA220AA	Mitsubishi Paper Mills, Ltd.
7	TYPE[8]			
8	TYPE[9]	Long preservation paper	AFP-235	Mitsubishi Paper Mills, Ltd.
9	TYPE[10]			
10	TYPE[11]			
11	TYPE[12]			

- (5) The initial value of parameter n is 3.
- (6) Setting 12-15 of parameters n is assumed to be a prohibition.

DOCUMENT CONTROL SECTION

DATE

				TITLE		FTP-628DCL30X Series Product Specification	
				DRAW No.		A1NA21207-3011/6	
						CUST	
EDIT	DATE	DESIGN	CHECK	DESCRIPTION			
DESIGN			CHECK	APPLY	FUJITSU TAKAMISAWA COMPONENT LIMITED		60/80

(31) GS e+n+m

[Name] Bar code width setting

[Function]

The GS e+n+m command sets the width of a bar code.

[Code] [1D]₁₆ [65]₁₆ [n] [m]
[29]₁₀ [101]₁₀ [n] [m]

[Explanation]

- (1) Parameter n specifies the width of a narrow bar in dots.
- (2) Parameter m specifies the width of a wide bar in dots.
- (3) When the code does not consist of wide bars and/or narrow bars, the value of parameter n is set as the minimum width.
- (4) The initial value of parameter n is 2. The initial value of parameter m is 6.
- (5) The following conditions must be satisfied:

$$1 \leq n \leq 255$$

$$1 \leq m \leq 255$$

A

B

C

D

A

B

C

D

E

F

DATE	↑
	DOCUMENT CONTROL SECTION

					TITLE		FTP-628DCL30X Series Product Specification	
					DRAW No.		A1NA21207-3011/6	
							CUST	
EDIT	DATE	DESIGN	CHECK	DESCRIPTION				
DESIGN			CHECK		APPLY	FUJITSU TAKAMISAWA COMPONENT LIMITED		61 / 80

(32) GS h+n

[Name] Bar code height setting

[Function]

The GS h+n command sets the height of a bar code.

[Code] [1D]₁₆ [68]₁₆ [n]
[29]₁₀ [104]₁₀ [n]

[Explanation]

- (1) Condition $1 \leq n \leq 255$ must be satisfied.
- (2) Parameter n specifies the height of a bar code in dots.
- (3) The initial value of parameter n is 60.

A

B

C

D

A

B

C

D

E

F

DOCUMENT CONTROL SECTION	↑
	DATE

					TITLE		FTP-628DCL30X Series Product Specification		
					DRAW No.		A1NA21207-3011/6		
							CUST		
EDIT	DATE	DESIGN	CHECK	DESCRIPTION				FUJITSU TAKAMISAWA COMPONENT LIMITED	
DESIGN			CHECK		APPLY		62 / 80		

(33) GS $k+m+n+d_1$ to d_n

[Name] Bar code printing

[Function]

The GS $k+m+n+d_1$ to d_n command selects a bar code type and prints a bar code.

[Code] [1D]₁₆ [6B]₁₆ [m] [n] [d₁] to [d_n]
[29]₁₀ [107]₁₀ [m] [n] [d₁] to [d_n]

[Explanation]

(1) Parameter m specifies the type of bar codes to be printed (see the following table):

m	Type of bar code	Number of records
65	UPC-A	Fixed ($11 \leq n \leq 12$)
66	Undefined	_____
67	JAN(EAN)13	Fixed ($12 \leq n \leq 13$)
68	JAN(EAN)8	Fixed ($7 \leq n \leq 8$)
69	CODE39	Variable
70	ITF	Variable
71	CODABAR	Variable

(2) The command configuration, code, definition area, and part of the conditions depend on parameter m.

(3) Parameter d specifies the character to be printed. If parameter d specifies a character code that cannot be printed when the data length is fixed, the corresponding bar code is not printed. If parameter d specifies a character code that cannot be printed when the data length is variable, the bar code prior to this command is printed but the subsequent data is handled as ordinary data.

(4) After a bar code is extended, the printing start position is set to the next dot of the bar code end data.

(5) If the print data exceeds the printing area of which width is one line, the overflowing part of the data is ignored.

(6) If the bar code is higher than the line spacing set with the ESC 2 or ESC 3 command, paper is fed by the bar code height without regard to the specified line spacing.

(7) When NUL is specified at the check digit position or when an odd number of data records is specified in ITF with m=70, the check digit is calculated automatically. The calculation results are added to the bar code. When data other than NUL is specified at the check digit position, the received data is expanded in the bar code without modifications.

(8) When one line contains both a bar code and characters to be printed, the bottom of these characters and the bottom of the bar code are aligned at the same level.

DATE DOCUMENT CONTROL SECTION

					TITLE		FTP-628DCL30X Series Product Specification	
					DRAW No.		A1NA21207-3011/6	
							CUST	
EDIT	DATE	DESIGN	CHECK	DESCRIPTION				
DESIGN			CHECK		APPLY		FUJITSU TAKAMISAWA COMPONENT LIMITED	63 / 80

(9) Two or more bar codes cannot be contained on the same line. If this GS command is received when there is a bar code in the print buffer, the data contained in the print buffer is automatically printed, after which the command is accepted.

(10) A code area which is available to be set by each bar codes is shown as below :

A kind of bar codes	Code area
UPC-A, ITF, EAN-13/8	'0' ~ '9'
CODE 39	'0' ~ '9', 'A' ~ 'Z', ',', '\$', '/', '+', '%'
CODABAR	'0' ~ '9', '-', '\$', ',', '/', ':', '+', 'A' ~ 'D'

A

B

C

D

A

B

C

D

E

F

DOCUMENT CONTROL SECTION	↑
	DATE

					TITLE		FTP-628DCL30X Series Product Specification		
					DRAW No.		A1NA21207-3011/6		
							CUST		
EDIT	DATE	DESIGN	CHECK	DESCRIPTION				FUJITSU TAKAMISAWA COMPONENT LIMITED	64 / 80
DESIGN			CHECK		APPLY				

(34) GS w+n

[Name] Bar code width magnification setting

[Function]

The GS w+n command sets the width magnification of a bar code.

[Code] [1D]₁₆ [77]₁₆ [n]
[29]₁₀ [109]₁₀ [n]

[Explanation]

- (1) Parameter n specifies the horizontal magnification of a bar code.
- (2) Condition $1 \leq n \leq 255$ must be satisfied.
- (3) The initial value of parameter n is 1.
- (4) Both the widths of a narrow bar and a wide bar is multiplied by n times.

A

B

C

D

A

B

C

D

E

F

DATE	DOCUMENT CONTROL SECTION	↑

					TITLE		FTP-628DCL30X Series Product Specification	
					DRAW No.		A1NA21207-3011/6	
							CUST	
EDIT	DATE	DESIGN	CHECK	DESCRIPTION				
DESIGN			CHECK		APPLY	FUJITSU TAKAMISAWA COMPONENT LIMITED		65 / 80

(35) FS E + n

[Name] Correction of impressed energy.

[Function]

Impressed energy is corrected.

[Code] [1C]₁₆ [45]₁₆ [n]
[28]₁₀ [69]₁₀ [n]

[Explanation]

(1) The correction value is set by n. The range of n is shown below.

$$0 \leq n \leq 255$$

(2) Impressed energy grows by the value of n large.

(3) Please note that the life of the head shortens when the impressed energy is too large.
There is danger to which the head is disconnected for $n \geq 128$.

(4) An initial value is n=52.

A

B

C

D

A

B

C

D

E

F

DATE	↑	DOCUMENT	CONTROL	SECTION

					TITLE		FTP-628DCL30X Series Product Specification	
					DRAW No.		A1NA21207-3011/6	
							CUST	
EDIT	DATE	DESIGN	CHECK	DESCRIPTION				
DESIGN			CHECK		APPLY	FUJITSU TAKAMISAWA COMPONENT LIMITED		66 / 80

(36) ESC V + n

[Name] Right rotation 90°.

[Function]

The character is rotated right by 90°.

[Code] [1B]₁₆ [56]₁₆ [n]
[27]₁₀ [86]₁₀ [n]

[Explanation]

(1) 90 ° rotation is specified by n and release is set.

n	set content
0	Rotation release of 90°
1	Rotation specification of 90°

(2) It is effective to all character kind.

(3) It is invalid concerning the barcode, the image, and the registration image.

(4) A standard print and the rotation print of 90° can exist together in the same line because an automatic changing is not done by this command.

(5) Character font becomes equal to 270° rotation (90° in left rotation) when 90° rotation is specified at upside-down printing.

(6) The direction of the expansion must not rotate with the character when you rotate the length double size and the double width character right by 90°.

DATE	↑	DOCUMENT	CONTROL	SECTION

					TITLE		FTP-628DCL30X Series Product Specification	
					DRAW No.		A1NA21207-3011/6	
							CUST	
EDIT	DATE	DESIGN	CHECK	DESCRIPTION				
DESIGN			CHECK		APPLY	FUJITSU TAKAMISAWA COMPONENT LIMITED		67 / 80

(37) ESC EM + n

[Name] Setting the amount of the feeding at automatic paper feed.

[Function]

The amount of the feeding at automatic paper feeding is set.

[Code] [1B]₁₆ [19]₁₆ [n]
[27]₁₀ [25]₁₀ [n]

[Explanation]

- (1) The amount of feeding is set by this command.
- (2) The set amount of feeding is n dot line.
- (3) The range of n is $0 \leq n \leq 255$. The automatic paper feed function becomes invalid for n = 0.
- (4) An initial value is about 20mm.

A

B

C

D

A

B

C

D

E

F

DATE	↑
	DOCUMENT CONTROL SECTION

					TITLE		FTP-628DCL30X Series Product Specification	
					DRAW No.		A1NA21207-3011/6	
							CUST	
EDIT	DATE	DESIGN	CHECK	DESCRIPTION				68 / 80
DESIGN			CHECK		APPLY		FUJITSU TAKAMISAWA COMPONENT LIMITED	

(38) GS V + n + m

[Name] Paper cut

[Function]

The paper cut is executed

[Code] [1B]₁₆ [56]₁₆ [n] [m]
[27]₁₀ [86]₁₀ [n] [m]

[Explanation]

(1) The relationship between parameter n and the operation is as follows:

n	Operation	Note
0, 48	Cut	Without m
65	Feed + Cut	With m

(2) When n is 65, paper cut executes after feeding related m. The parameter m indicates the amount of feeding.

(3) The parameter m indicates dot line and can be set range is $0 \leq m \leq 255$.

A

B

C

D

A

B

C

D

E

F

DATE	↑	DOCUMENT CONTROL SECTION

					TITLE FTP-628DCL30X Series Product Specification	
					DRAW No. A1NA21207-3011/6	
					CUST	
EDIT	DATE	DESIGN	CHECK	DESCRIPTION		
DESIGN			CHECK	APPLY	FUJITSU TAKAMISAWA COMPONENT LIMITED	
					69 / 80	

(39) ESC X + n + m

[Name] Setting the turning time of the motor excitation.

[Function]

The turning off time of the motor excitation current is set.

[Code] [1B]₁₆ [58]₁₆ [n] [m]
[27]₁₀ [88]₁₀ [n] [m]

[Explanation]

- (1) The off time of motor exciting after feeding or print stopping is set.
- (2) n sets one excitation time after the motor stops in 0.5 seconds.
- (3) m sets time from the motor stop to turning off in 0.5 seconds.
- (4) The time that can be set range is as follows.
 $0 \leq m \leq n \leq 255 \quad 0 \leq m \leq 20$
- (5) An initial value is m=10 and n=20.
- (6) The difference of the time of n and m has been excited by one aspect in a slight current.
- (7) When parameter n specifies 255, Motor OFF does not do.

A

B

C

D

A

B

C

D

E

F

DATE	↑	DOCUMENT	CONTROL	SECTION

					TITLE		FTP-628DCL30X Series Product Specification	
					DRAW No.		A1NA21207-3011/6	
							CUST	
EDIT	DATE	DESIGN	CHECK	DESCRIPTION				
DESIGN			CHECK		APPLY		FUJITSU TAKAMISAWA COMPONENT LIMITED	
							70	80

SECTION H

List of Character Codes

1. The domestic (JAPAN) Character Codes

UPPER LOWER	0	1	2	3	4	5	6	7	8	9	A	B	C	D	E	F
0			SP	0	@	P	`	p	_	±	SP	-	タ	ミ	=	×
1			!	1	A	Q	a	q	-	〒	。	ア	チ	ム	ト	円
2		DC2	"	2	B	R	b	r	-	〒	「	イ	ツ	メ	≠	年
3			#	3	C	S	c	s	■	ト	」	ウ	テ	モ	≠	月
4			\$	4	D	T	d	t	■	—	,	エ	ト	ヤ	▲	日
5			%	5	E	U	e	u	■	—	・	オ	ナ	ユ	▲	時
6			&	6	F	V	f	v	■		ヲ	カ	ニ	ヨ	▼	分
7			'	7	G	W	g	w	■		ァ	キ	ヌ	ラ	▼	秒
8			(8	H	X	h	x		「	イ	ク	ネ	リ	♠	〒
9	HT	EM)	9	I	Y	i	y	!	「	ウ	ケ	ノ	ル	♥	市
A	LF		*	:	J	Z	j	z	!	「	エ	コ	ハ	レ	♦	区
B		ESC	+	;	K	[k	{	!	「	オ	サ	ヒ	ロ	♣	町
C	FF	FS	,	<	L	¥	l	!	!	「	ヤ	シ	フ	ワ	●	村
D		GS	-	=	M]	m	}	!	「	ユ	ス	ヘ	ン	○	人
E			.	>	N	^	n	~	!	「	ヨ	セ	ホ	°	/	■
F			/	?	O	_	o	SP	+	ノ	ッ	ソ	マ	°	\	SP

(In this table, "SP" indicates a space.)

Note:

- Each code is represented in hexadecimal notation.
- If an undefined code ([00]₁₆ to [1F]₁₆) or an undefined ESC, FS, or GS sequence listed in this table is received, an abnormal operation may occur. (However, when image print data, character registration data, or command parameters are received, they are handled as ordinary data.)

DOCUMENT CONTROL SECTION

				TITLE		FTP-628DCL30X Series Product Specification	
				DRAW No.		A1NA21207-3011/6	
						CUST	
EDIT	DATE	DESIGN	CHECK	DESCRIPTION			
DESIGN			CHECK	FUJITSU TAKAMISAWA COMPONENT LIMITED		71 / 80	

2. Overseas (Foreign) Character Codes

LOWE	IIPPER															
	0	1	2	3	4	5	6	7	8	9	A	B	C	D	E	F
0			SP	0	@	P	`	p	ç	É	á	::	L	⊥	α	≡
1			!	1	A	Q	a	q	ü	æ	í	⊗	⊥	⊥	β	±
2		DC2	"	2	B	R	b	r	é	Æ	ó	⊗	⊥	⊥	Γ	≥
3			#	3	C	S	c	s	â	ô	ú		⊥	⊥	π	≤
4			\$	4	D	T	d	t	ä	ö	ñ	⊥	⊥	⊥	Σ	†
5			%	5	E	U	e	u	à	ò	Ñ	⊥	⊥	⊥	σ	∫
6			&	6	F	V	f	v	á	û	ä	⊥	⊥	⊥	μ	÷
7			'	7	G	W	g	w	ş	ü	ø	⊥	⊥	⊥	τ	≈
8			(8	H	X	h	x	ê	ÿ	ó	⊥	⊥	⊥	Φ	•
9	HT	EM)	9	I	Y	i	y	ë	Ö	⊥	⊥	⊥	⊥	Θ	•
A	LF	EM	*	:	J	Z	j	z	è	Ü	⊥	⊥	⊥	⊥	Ω	•
B		ESC	+	;	K	[k	{	ï	ç	½	⊥	⊥	■	δ	√
C	FF	FS	,	<	L	¥	l	!	î	£	¼	⊥	⊥	■	∞	n
D		GS	-	=	M]	m	}	ï	¥	ì	⊥	⊥	■	φ	²
E			.	>	N	^	n	~	Ä	Ð	«	⊥	⊥	■	ε	▪
F			/	?	O	_	o	SP	Å	f	»	⊥	⊥	■	∩	SP

Note:

- Each code is represented in hexadecimal notation.
- If an undefined code ([00]₁₆ to [1F]₁₆) or an undefined ESC, FS, or GS sequence listed in this table is received, an abnormal operation may occur. (However, when image print data, character registration data, or command parameters are received, they are handled as ordinary data.)

DOCUMENT CONTROL SECTION

DATE

					TITLE		FTP-628DCL30X Series Product Specification	
					DRAW No.		A1NA21207-3011/6	
							CUST	
EDIT	DATE	DESIGN	CHECK	DESCRIPTION				
DESIGN			CHECK	APPLY		FUJITSU TAKAMISAWA COMPONENT LIMITED		72 / 80

SECTION I

Packaging, Stamping, Soldering, and Other Conditions

A

1. Stamping

The name, the serial number, and the number of versions of products are displayed in the our company standard label in this control board.

2. Packaging

This control board is packed based on the packing specification of the our company standard.

3. Other Conditions

- (1) Detected errors must be resolved by mutual agreement in accordance with this specification.
- (2) To change the contents of this specification, the changes must be reported on and mutually agreed upon in advance.
- (3) The model described in this specification is the standard model. Therefore, when functional compatibility is maintained, the items not described in this specification may be changed without prior notice.
- (4) If more detailed information is required or ambiguous information is detected, these problems must be resolved by mutual agreement.

B

C

D

DATE	DOCUMENT	CONTROL	SECTION
↑			

					TITLE		FTP-628DCL30X Series Product Specification	
					DRAW No.		A1NA21207-3011/6	
							CUST	
EDIT	DATE	DESIGN	CHECK	DESCRIPTION				
DESIGN			CHECK		APPLY	FUJITSU TAKAMISAWA COMPONENT LIMITED		73 / 80

A

B

C

D

E

F

Appendix 1 Configuration of Character Typeface

1. Relationship between character typeface and print character area

(1) Internal half-size [12 x 24 dots] character typeface (internal data = print pattern)

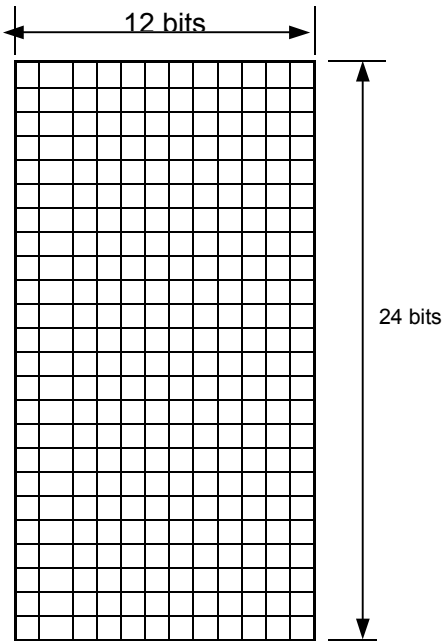

(2) Internal full-size [24 x 24 dots] character typeface (double-width typeface of internal half-size characters)

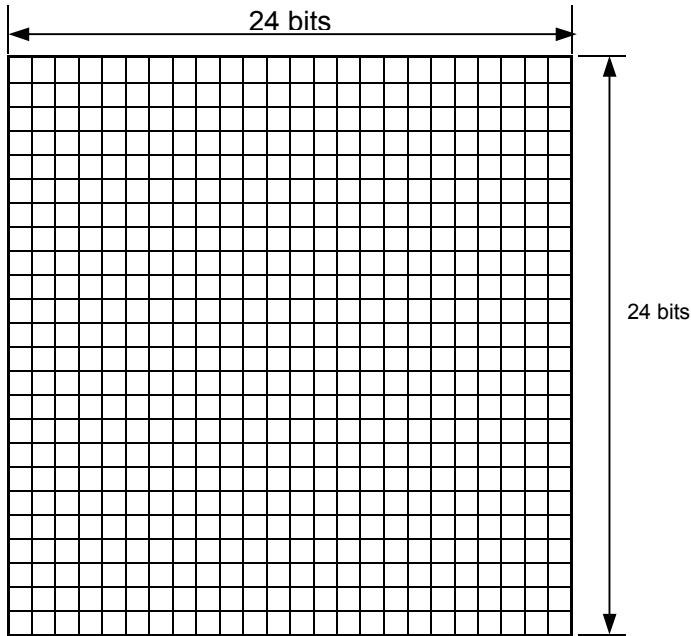

DATE	DOCUMENT CONTROL SECTION
------	--------------------------

				TITLE		FTP-628DCL30X Series Product Specification	
				DRAW No.		A1NA21207-3011/6	
						CUST	
EDIT	DATE	DESIGN	CHECK	DESCRIPTION			
DESIGN			CHECK		APPLY	FUJITSU TAKAMISAWA COMPONENT LIMITED	
						74 / 80	

(3) Internal half-size [8 x 16 dots] character typeface (internal data = print pattern)

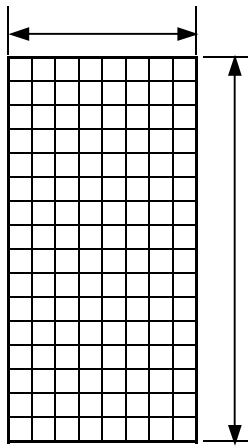

A

A

(4) Internal full-size [16 x 16 dots] character typeface (double-width typeface of internal half-size characters)

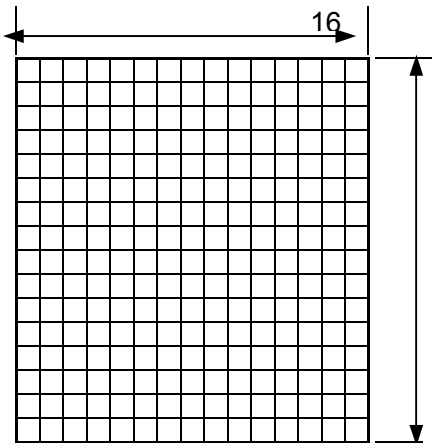

B

B

C

C

D

D

DATE	↑	DOCUMENT CONTROL SECTION

					TITLE		FTP-628DCL30X Series Product Specification	
					DRAW No.		A1NA21207-3011/6	
							CUST	
EDIT	DATE	DESIGN	CHECK	DESCRIPTION		FUJITSU TAKAMISAWA COMPONENT LIMITED		75 / 80
DESIGN			CHECK		APPLY			

E

F

Appendix 2 Paper Printing Area and Mark Detection Position

1. Paper printing area

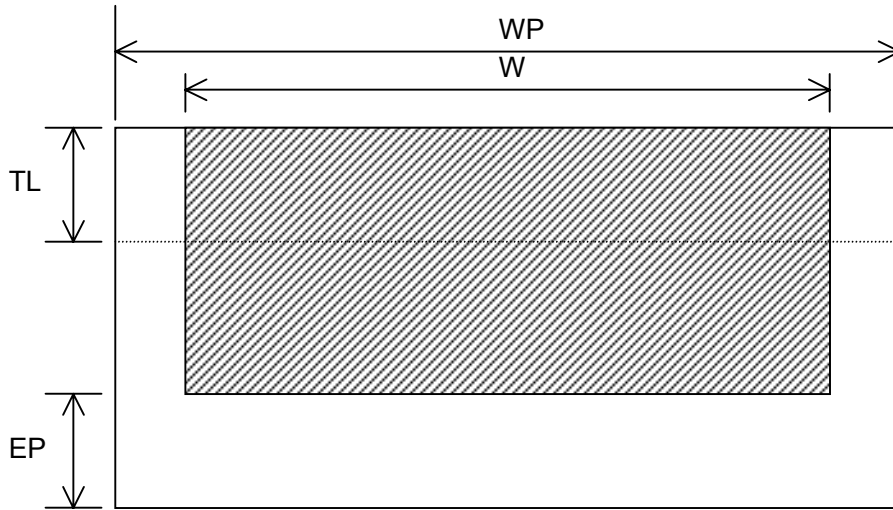

Symbol	Explanation		Length (mm)
WP	Maximum paper Width	FTP-628MCL or equivalent product	About 58
		FTP-638MCL or equivalent product	About 80
W	Maximum printable area	FTP-628MCL or equivalent product	About 48
		FTP-638MCL or equivalent product	About 72
EP	Paper-out state detection position	FTP-628MCL or equivalent product	About 8.4* ¹
		FTP-638MCL or equivalent product	About 8.4* ¹
TL	Distance from paper cut position to print position (Auto cutter use)		About TBD

Note *1) This value varies with the printing mode used.

2. Mark detection position (when head detection distance is 2 mm)

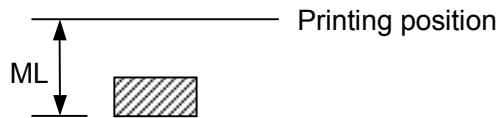

Symbol	Explanation	Length (mm)
ML	Distance from mark position to printing position	About 6.4

DOCUMENT CONTROL SECTION

DATE

					TITLE		FTP-628DCL30X Series Product Specification	
					DRAW No.		A1NA21207-3011/6	
							CUST	
EDIT	DATE	DESIGN	CHECK	DESCRIPTION				
DESIGN			CHECK		APPLY	FUJITSU TAKAMISAWA COMPONENT LIMITED		76 / 80

Appendix

List of Commands

A

- (1) HT : Horizontal tab
- (2) LF : Line feed with printing
- (3) FF : Forms feed
- (4) DC2 : Power down
- (5) ESC RS : Black-white reversed printing specification
- (6) ESC US : Black-white reversed printing cancellation
- (7) ESC !+n : Printing mode specification
- (8) ESC %+n : External registration character specification/cancellation
- (9) ESC &+y+c1+c2+x+[d]k : External registration character definition
- (10) ESC *+m+n1+n2+[d]k : Bit image mode specification
- (11) ESC ?+n : External registration character deletion

B

- (12) ESC 2 : 1/6-inch line pitch setting
- (13) ESC 3+n : Minimum-pitch-unit line pitch setting
- (14) ESC @ : Printer initialization
- (15) ESC A+n : Line spacing setting
- (16) ESC C+n : Page length (number of lines) setting
- (17) ESC D+[n]k+NUL : Horizontal tab position setting
- (18) ESC J+n : Printing and minimum-pitch-unit paper feed
- (19) ESC K+n : Backward paper feed
- (20) ESC R+n : International character specification
- (21) ESC c+1+n : Internal processing setting
- (22) ESC d+n : Printing and n-line feed

C

- (23) ESC e+n : Printing and backward n-line feed
- (24) ESC s+n : Printing speed setting
- (25) ESC t+n : Character code table selection
- (26) ESC {+n : Upside-down printing setting/cancellation
- (27) FS 9+n : Detection function enable/disable setting
- (28) GS < : Mark detection execution
- (29) GS A+m+n : After-mark-detection head detection distance setting
- (30) GS E+n : Print quality setting
- (31) GS e+n+m : Bar code width setting
- (32) GS h+n : Bar code height setting
- (33) GS k+m+n+[d]k : Bar code printing
- (34) GS w+n : Bar code width magnification setting

D

- (35) FS E+n : Correction of impressed energy
- (36) ESC V+n : Right rotation 90°
- (37) ESC EM+n : Setting the amount of the feeding at automatic paper feed.
- (38) GS V+n+m : Paper cut
- (39) ESC X+n+m : Setting the turning time of the motor excitation

DATE	SECTION
DOCUMENT	CONTROL

				TITLE		FTP-628DCL30X Series Product Specification	
				DRAW No.		A1NA21207-3011/6	
						CUST	
EDIT	DATE	DESIGN	CHECK	DESCRIPTION			
DESIGN			CHECK		APPLY	FUJITSU TAKAMISAWA COMPONENT LIMITED	
						77 / 80	

Appendix 5 Conditions for Use

A

To use the printer with this control board built in, the following conditions must be satisfied.

(1) Power supply

- a. The power supply unit that satisfies the specified specifications must be used. If a power supply unit that does not satisfy the specified specifications is used, normal operation is not assured and errors may occur.
- b. When the power is turned on, the MCU must stop until voltage of VH system becomes approx. 3.8 V or higher and enters in the state of the standby.
- c. The MCU automatically controls the print density in accordance with the detected power voltage. The power voltage is detected every four dot-lines. If the print head power voltage changes during this period, the density cannot be controlled. If the power voltage changes extremely, an overload may apply to the print head. To prevent this, the print head voltage variation must be kept within $\pm 5\%$.

B

(2) The printing head heat

The print head becomes a high temperature very much along with the print. Please do not touch the print head and the support board directly by the hand.

When the print head is pulled down with paper run out state, praten might be transformed by heat.

C

(3) The motor heat

The motor and motor drive element become a high temperature. Please do not touch by the hand.

(4) Cutter

Please don't insert fingers or foreign matters to the cutter part. Injuries may be receive or troubles may occur.

(5) Paper

- a. The recommended paper is wound on a roll. The external side of the rolled paper is the heat-sensitive side. Set the paper so that the heat-sensitive side can touch the print head.
- b. If paper is set so that its edge is oblique to the paper guide, a skew feed or jam may occur. Set paper so that its edge is parallel to the paper guide.
- c. If the paper that does not satisfy the specified specifications is used, the print quality is not assured and errors may occur.
- d. Heat-sensitive paper is liable to deteriorate in a high-temperature, high-humidity environment. Especially when the temperature increases up to 60 °C or higher, coloring may occur. Carefully store heat-sensitive paper.

D

DOCUMENT CONTROL SECTION	↑
	DATE

					TITLE		FTP-628DCL30X Series Product Specification	
					DRAW No.		A1NA21207-3011/6	
							CUST	
EDIT	DATE	DESIGN	CHECK	DESCRIPTION				
DESIGN			CHECK		APPLY		FUJITSU TAKAMISAWA COMPONENT LIMITED	78 / 80

A

B

C

D

E

F

(6) Paper jam

When the paper jam is generated, the power supply of the printer is cut and please raise the head and remove the paper. When working without turning off the power supply of the printer, if the connector comes off, the head is occasionally damaged. Moreover, causes the printer to break down when the printing in the state of the form jam.

(7) Water and foreign matter

- a. Adhering liquid such as water or metal chips such as needles and pins to the control board may cause a printer failure.
- b. If printing is performed in a condensation state, the print head may be damaged. If condensation is occurred, let the printer dry sufficiently before starting printing.

(8) Impact

Because this product is made of precision electronic and mechanical components, do not drop it or hit it with a solid object. Applying the force of an impact to the product may cause errors to occur.

(9) When not using for a long time

When the printer is not used for a long time, please put into the state to raise the head. When the head is left lowered, praten might be transformed.

(10) Installation

- a. This product must be kept horizontally as much as possible. Use this product in a place free of vibration.
- b. Please ground the printer mechanism to FG (frame playground) surely.
- c. The printer with this board mounted must not be used in an environment subject to direct sunlight or dust (oil or iron dust).
- d. The power supply line must be separated from other devices (e.g., large-sized motors) that cause noise.
- e. The printer with this board built in must be installed so that it is positioned as far away as possible from large-noise-emitting devices such as high-voltage devices and large-sized motors.
- f. To connect or remove the connector, always turn off the power in advance. If the connector is connected or removed while the power to the printer is on, errors may occur.
- g. Please lock surely, and connect the connector of connected each cable correctly. There is no lock mechanism in the connector on the head side and confirm insertion up to the deepest part, please.

DOCUMENT CONTROL SECTION	↑
	DATE

					TITLE		FTP-628DCL30X Series Product Specification	
					DRAW No.		A1NA21207-3011/6	
							CUST	
EDIT	DATE	DESIGN	CHECK	DESCRIPTION				
DESIGN			CHECK		APPLY	FUJITSU TAKAMISAWA COMPONENT LIMITED		79 / 80

h. Impossible power must not join each cable when you mount the printer on the device. Especially, it is necessary to note because the head connection cable influences the pressurizing power of the head. Moreover, please note that causes abnormal heating and the head damage, etc. of the head when the connection of the head connector is imperfect enough about the connector connection.

i. If continuous printing is performed at a high print rate (high print density), the head heat may build up and the head temperature may exceed the maximum usable temperature. In this case, printing may be stopped by the thermal error detection function. Printing resumes automatically after the head cools down to the print enabling temperature.

j. To connect or remove the cutter, always turn off the power of the printer in advance. If the cutter is connected or removed while the power to the printer is on, it is very dangerous because the cutter may move.

k. If power is supplied to the print head for a long period of time, the heater may undergo electrolytic corrosion. If the no-printing state continues for a long period of time, turn off the power to the print head and set the printer to the standby state. (See the "FS 9" (detection function setting command).)

A

B

C

D

A

B

C

D

E

F

DATE	↑	DOCUMENT	CONTROL	SECTION

					TITLE		FTP-628DCL30X Series Product Specification	
					DRAW No.		A1NA21207-3011/6	
							CUST	
EDIT	DATE	DESIGN	CHECK	DESCRIPTION				
DESIGN			CHECK		APPLY	FUJITSU TAKAMISAWA COMPONENT LIMITED		80 / 80